

City of **Boston** - Department of
**Neighborhood
Development**

2020

guidebook for **Zero Emission Buildings (ZEBs)**



PLACETAILED

elton+hampton
architects

**Thornton
Tomasetti**



BENSONWOOD

acknowledgments

City of Boston

Mayor Martin J. Walsh

Department of Neighborhood Development (DND)

Sheila Dillon - *Chief of Housing and Director of Neighborhood Development*
Jessica Boatright - *Deputy Director, Neighborhood Housing Development*
Jay Lee, AIA, NOMA - *Assistant Director of Design Construction Openspace*
John Feuerbach - *Senior Development Officer*
Carl Hedman - *Fellow*

Boston Planning and Development Agency (BPDA)

John Dalzell, AIA, LEED Fellow - *Senior Architect for Sustainable Development*

Boston Environment Department

Alison Brizius - *Director of Climate and Environmental Planning*

Placetaylor - Integrated Development / Design / Build

Travis Anderson, CPHC - *Director of Design Studio, Project Lead*
Colin Booth - *Strategic Director*
Michelangelo Latona, AIA - *Architect*
Evan Smith - *Director of Operations*
Jesse Ware - *Construction Project Manager*

Elton Hampton Architects - Affordable Housing

Nick Elton, AIA - *Principal*

Thornton Tomasetti - Energy Modeling / Data Analysis

Colin Schless, CPHC, LEED AP BD+C - *Vice President*

Bensonwood - Prefabricated Building Systems

Chris Carbone, PE - *Company Steward / Engineer*

Thank you to the stakeholders who attended workshops and provided feedback and insights for this study.

contents

1 | introduction

a | executive summary 5

b | how to use this guidebook 6

c | carbon 101 7
glossary
introduction to carbon emissions
carbon reduction path

d | methodology 13
context
building elements analyzed
typologies
materials
parametric energy modeling
building v portfolio
cost per category
modeled results

2 | best practices

a | what is a ZEB? 24

b | key strategies 25
massing
orientation
impacts of unit density
glazing percentages
thermal bridging and r-value
air tightness
ventilation
assembly summary

3 | typologies

a | introduction 36

b | small multifamily 37
case study
recommendations

c | 3 story multifamily 46
case study
recommendations

d | 4 - 5 story multifamily 55
case study
recommendations

e | 6 story multifamily 64
case study
recommendations

4 | appendices

a | sources and resources 74

b | variations 75

c | tools for embodied carbon 76

d | about this guide 78

1 | introduction

a | executive summary

b | how to use this guidebook

c | carbon 101

d | methodology

executive summary

In 2017 Mayor Martin J. Walsh set a goal of Carbon Neutrality in the City of Boston by 2050. The 2019 Carbon Free Boston Summary Report outlined the reasoning, framework, and broad strategies for how the City must lead the way to reduce carbon emissions as soon as possible to do its part in avoiding the worst effects of climate change.

This study is the result of Boston's Department of Neighborhood Development (DND) taking up Mayor Walsh's challenge to answer the question, "can we make DND's portfolio of new construction affordable housing carbon neutral?"

The answer is a resounding YES, we can and we can NOW.

In this study the team identified performance criteria - tailored to Boston's specific climate, portfolio, density, and resiliency goals - based upon proven, cost-effective design and construction strategies for buildings that are zero carbon, healthier for occupants, and cost less to operate. The resulting recommendations vary between building typologies, are based upon

cutting edge parametric energy modeling techniques, and incorporate cost data from numerous Zero Net Energy and Passive House projects in Boston.

The team discovered that there is little-to-no cost increase for building to Zero Emission Building (ZEB) standards. Total construction cost increases range from 2.5% or less before rebates and incentives are considered. The rebates and incentives currently available have the potential to make these buildings less expensive to build, with additional long-term operational savings.

Many of the criteria for these guidelines align with the development of stretch energy codes and standard best building practices. The study highlighted that careful consideration to just a few areas (some at low-to-zero cost) provided the most important impact on the performance of ZEBs. **Specifically, window performance, window-to-wall ratio, and air tightness are key items for extra care.**

This guidebook aims to provide developers, designers, and builders with a resource to set them on a path to Zero Emission Buildings.

While performed completely independently, this study produced results that align with similar studies performed by the United Nations Intergovernmental Panel on Climate Change (UN IPCC), The Rocky Mountain Institute (RMI), and the Massachusetts chapter of the United States Green Building Council (USGBC). Specifically, window performance, window-to-wall ratio, and air tightness are key items for extra care.

"The GHG emissions from the use of electricity, heating oil, natural gas, and steam in Boston's buildings account for more than two-thirds of the City's total emissions..."

Boston is in the midst of a major building boom, adding 4 million to 6 million square feet per year of new building space since 2014. Advancing new buildings to high energy performance standards, including net-zero or net-positive, will result in fewer emissions and prevent the need for future retrofits in these buildings..."

Timing is a key driver of the magnitude of emission reductions in new buildings. For example, the implementation of a net-zero policy for all new buildings in 2030 reduces cumulative emissions by 17 percent. Earlier implementation of the same policy reduces emissions by an additional 25 percent. This is a consistent theme that emerges from our analysis in every sector: early action builds on itself and makes it easier to reach the carbon-neutral target."

- Carbon Free Boston Summary Report
2019 p.34, 39

how to use this guidebook

This guidebook is designed to be accessible to all parties involved in the planning, design, & construction of affordable housing in the City of Boston and a comprehensive companion to the forthcoming DND ZEB design and construction requirements.

The guidebook is intended to bridge the gaps between building scientists, engineers, energy consultants, architects and builders. It captures decades of collective experience into a how-to instruction manual of process, standards, considerations, means and methods for realizing a new generation of “Future Housing”. With this, Boston continues on its path to carbon neutrality.

Developers, designers, and builders can use this guidebook to reference the specific ZEB requirements for each typology, check for allowable variations and trade-offs of those requirements, and utilize the case studies as a reference for how real ZEB projects have achieved this standard at no net or minimal cost increase.

glossary of terms and abbreviations

TYOLOGIES

- Small Multifamily** - approximately 1 - 9 units
- 3 Story Multifamily** - approximately 9 - 30 units
- 4-5 Story Multifamily** - approximately 30 - 50 units
- 6 Story Multifamily** - more than 50 units

(ACH50) - Air Changes per Hour at 50 pascals of net volume

(ASHRAE) - American Society of Heating and Air-Conditioning Engineers

(BPDA) - Boston Planning and Development Agency

(BTU) - British Thermal Unit

Builder - A member of the build-team for a project, whether general contractor or sub-contractor

Carbon Footprint - The total amount of Green House Gases to directly and indirectly support human activity. Equivalent tons of Carbon Dioxide

(CDD) - Cooling Degree Day

(CFA) - Conditioned Floor Area

(CFM50) - Cubic Feet per Minute at 50 pascals of gross surface area

(CO2e) - Carbon Dioxide Equivalent or metric tons of greenhouse gases in a common unit which have a global warming impact.

Climate Change - An increase in the earth's surface temperature over time that is attributed to increased levels of carbon dioxide in the atmosphere.

(CMR) - Code of Massachusetts Regulations

(COP) - Coefficient Of Performance

Designer - A member of the design-team for a project, whether architect or consultant/engineer

Developer - A member of the development-team for a project, whether the owner or owner's project

manager or financier

(DND) - Department of Neighborhood Development (Boston)

(DOER) - Department Of Energy Resources (Massachusetts)

E+ - A City of Boston program developing energy positive LEED Platinum residential buildings

(EER) - Energy Efficiency Ratio

(EF) - Energy Factor

Embodied Carbon - the amount of carbon emissions produced in the manufacture of a material, appliance, or assembly

(ERV) - Energy Recovery Ventilator

(EUI) - Energy Use Intensity

(GC) - General Contractor

(GHG) - Green House Gas

(HDD) - Heating Degree Day

(HERS) - Home Energy Rating System

(HRV) - Heat Recovery Ventilator

(HVAC) - Heating Ventilation and Air-conditioning

(IAQ) - Indoor Air Quality

(IBC) - International Building Code

(IEA) - International Energy Agency

(IECC) - International Energy Conservation Code

(IPCC) - Intergovernmental Panel on Climate Change

Mass CEC - Massachusetts Clean Energy Center

Mass Save - Coalition of Massachusetts utility providers with the goal of aiding consumers with energy efficient goals

Net-positive - A building that produces more energy than it consumes, either on-site or otherwise

Net-zero - A building that produces or offsets as much energy as it consumes

glossary of terms and abbreviations continued

Parametric Energy Modeling - Computer programming script that allows the designer to subject uncertain situations to the rigors of a predefined and proven mathematical model.

Passive House - A building standard that is truly energy efficient, comfortable, affordable and ecological at the same time.

(PHPP) - Passive House Planning Package - building performance modeling tool

(PV) - Photovoltaic

(QA) - Quality Assurance

(QC) - Quality Control

R-value - The capacity of an insulating material to resist heat flow. The higher the R-value, the greater the insulating power.

Resiliency - The ability [of Buildings] to withstand or adapt to disruptive events.

(RH) Relative Humidity

(SEER) - Seasonal Energy Efficiency Ratio

(SHGC) - Solar Heat Gain Coefficient

Stretch Code - Emphasizes energy performance, as opposed to prescriptive requirements, is designed to result in cost-effective construction that is more energy efficient than that built to the “base” energy code

(USGBC) - United States Green Building Council

U-value - measure of heat transmission through a building part (e.g. window u-value) higher = more heat transmission

WUFI-Plus - Energy modeling software, heat and moisture simulation tool

(ZEB) - Zero Emission Building

(ZNE) - Zero Net Energy



introduction to carbon dioxide

A colorless, odorless gas produced by burning carbon and organic compounds and by respiration. It is naturally present in air (about 0.03 percent) and is absorbed by plants in photosynthesis. When the amount of CO₂e that is emitted can no longer be absorbed naturally by the biological cycle it is trapped in the atmosphere. This trapped CO₂ (also known as GHGs) is contributing to an increase in temperatures across the planet.

As of 2017 CO₂ accounted for 81% of the Green House Gas (GHG) emissions and was driven in large part by the burning of fossil fuels attributed to human activity. In Boston, energy use in the building sector dominates, accounting for 71% of total emissions (4.5 MtCO₂e). Within the building sector commercial, industrial, and large residential buildings generated 52% of emissions (3.3 MtCO₂e), while small residential buildings account for 19% of building emissions (1.2 MtCO₂e).* (source: Boston GHG inventory 2005-2016)

We are now at an imbalance.

As a result the City of Boston has outlined **three broad strategies** to reduce demand for energy in the housing sector.

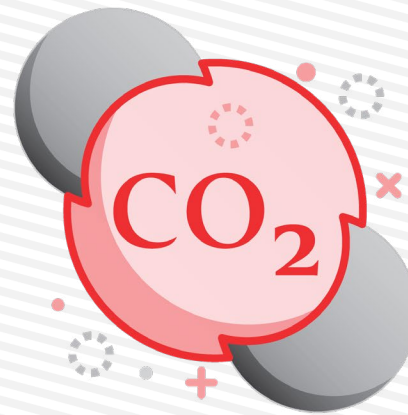

1. Increase efficiency.
2. Convert nearly everything that runs on fossil fuels to run on electricity.
3. Buy 100% clean energy.

emissions

The City of Boston anticipates a population increase of 75,000 within the next ten years reaching a total population of 760,000 by 2030, according to a recent study by the Boston Planning and Development Agency. This growth corresponds to an average of 400 sf per person or an additional 30,000,000 sf of residential floor area within the next ten years. DND recognizes as the city grows and there is a need to produce more housing, it is very important to take a closer look at reducing carbon emissions across the building sector and more specifically in residential construction.

According to a 2015 report by the Passive House Institute US and the US Department of Energy titled *Climate Specific Passive House Building Standards* in order to limit a 2°C global temperature rise set forth by the IPCC (International Panel on Climate Change) and the Kyoto Protocol, an annual energy or carbon per person budget is needed.

This idea of equally allocating emissions to each living person globally assumes a linear path in

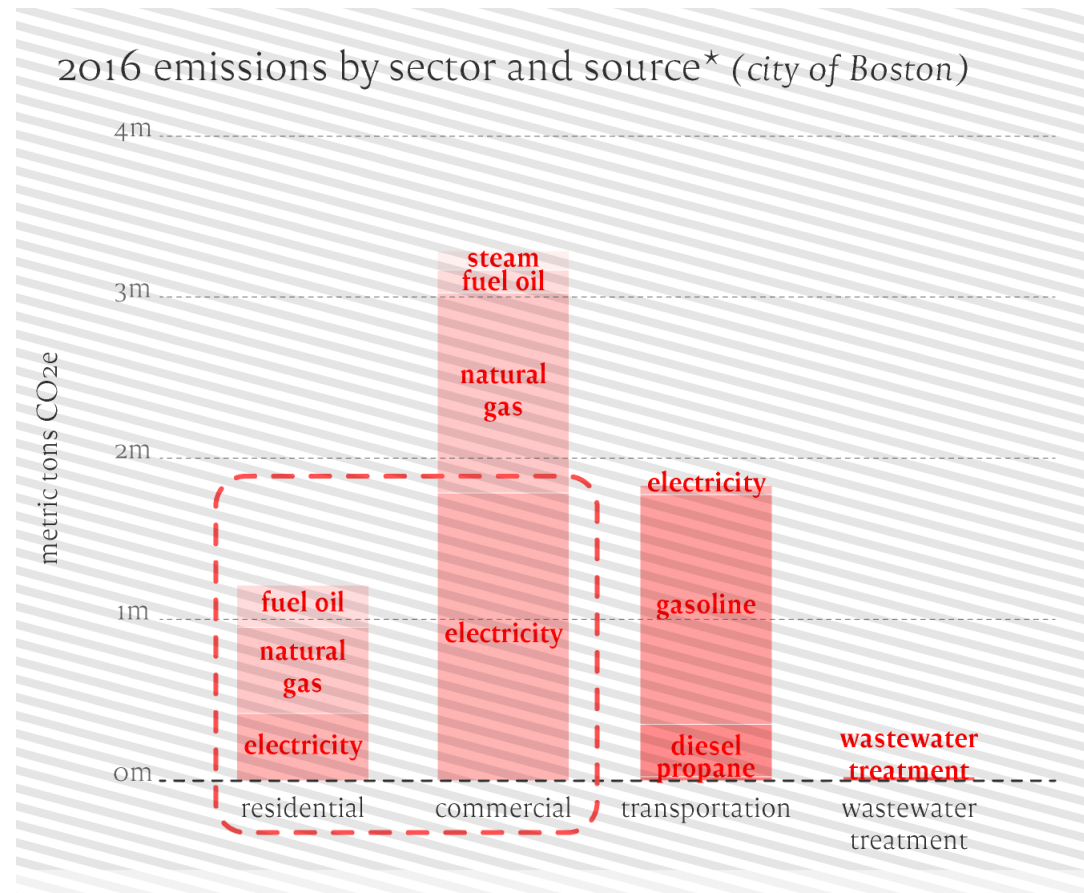

reducing carbon emissions to zero in 2050. In both studies, a budget of 2.2-3.8 tons/year would represent the total emissions assigned to each person.

As of 2018, the City of Boston stands at a total emissions of 9.5 tons/person/year, still well above the 2050 target. The building sector in Boston currently accounts for 28%–33% of the

total emissions per person per year, or approximately 2.85/tons/person annually. Significant reductions in the tons of Co₂/person used annually in buildings is required to meet the 2050 carbon reduction goals in the building sector.

Therefore the City of Boston has set a series of objectives to put buildings on a path to zero emissions.

carbon reduction path - 2050 objectives

- Meet 2050 Zero Emission Building Standards today. Avoid the need to retrofit buildings to meet 2050 guidelines later, saving money and resources long term.

- All new construction buildings to be net zero by 2030 or sooner.

- Develop a simple and cost effective performance measure for residential buildings to reach this goal.

- Outline a performance standard amongst four DND specified typologies.

- 1. Small Multifamily**
- 2. 3 Story Multifamily**
- 3. 4 - 5 Story Multifamily**
- 4. 6 Story Multifamily**

The following study determined that buildings designed to a target budget of 0.7-1.1 tons/person/year, or 1800kWh person annually, will achieve the zero emissions goals ahead of 2050. This budget target aligns with 2050 goals set forth by IEA and DOE/PHIUS for carbon reduction in the residential sector.

In cases where the building is limited due to site constraints this target can be further augmented with off-site carbon reductions. It is also estimated that by 2050 future clean grid technology will further help the carbon budget per person on an annual basis.

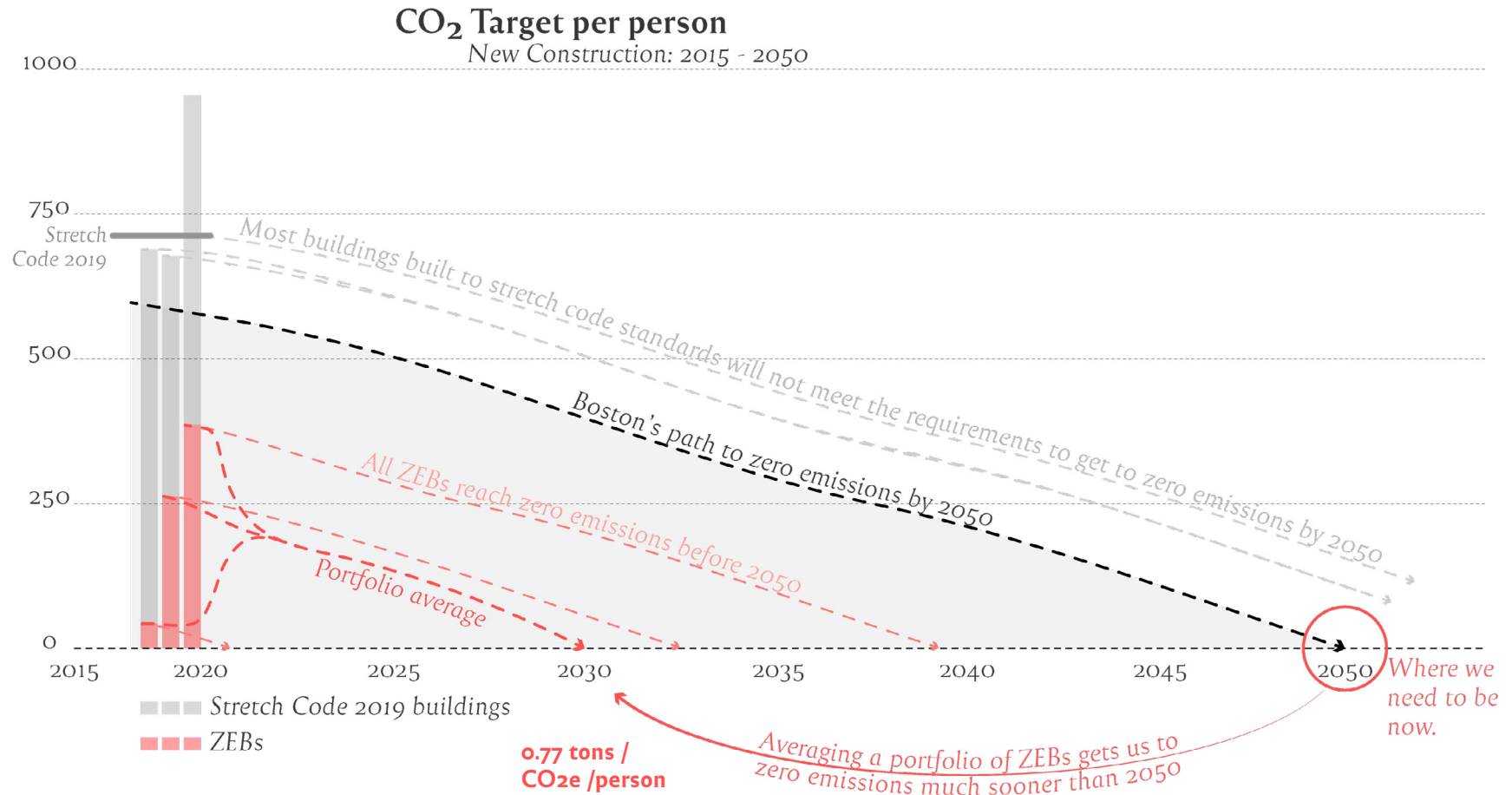

methodology

context, building elements analyzed, typologies, and materials

context

The City of Boston's Climate Action Plan calls for the construction of new buildings to be zero carbon by 2030. Leading by example, the Department of Neighborhood Development seeks to establish zero emission standards starting in 2020 - greatly reducing the amount of emissions in the small residential to medium residential building sector. Massachusetts Stretch Code - 2015 IECC acts as the baseline criteria for this study. Other metrics considered are Passive House United States standards and ASHRAE 90.1.

building elements analyzed

The assembly components below were selected because they have the greatest impact on a building's EUI - Energy Use Intensity - the building's annual energy use relative to its gross square footage.

- Window U-value
- Window Solar Heat Gain Coefficient
- Air Tightness (ach50/sf)
- Heat recovery ventilation efficiency
- Domestic Hot Water System Efficiency (COP)
- Heating + Cooling System Efficiency (COP)
- Roof R-Value
- Wall R- Value
- Floor R- Value
- Photovoltaics - Percentage of Roof Area

typologies

Working in conjunction with Department of Neighborhood Development, the team analyzed 4 typologies based on current and projected projects in the DND portfolio.

The following were used to develop the prescriptive path:

- Small multifamily (6+ units)
- 3 story multifamily (14+ units)
- 4 - 5 story multifamily (40+ units)
- 6 story multifamily (50+ units)

Note: This study focuses on residential units only - commercial space has been excluded at this time.

materials

Though the study team's area of focus was on the major assemblies and elements of construction, trends in wood construction and the use of prefabricated systems, they were very aware of the life cycle analysis of materials and the research surrounding the embodied carbon in materials. This guidebook delves into best practice assemblies with embodied carbon of the materials in mind, and understands its growing traction within the building industry, but does not specifically study embodied carbon.

Toxicity and health impacts of materials is also a critically important issue. **Therefore the team recommended avoiding the use of foams - XPS, EPS and Poly-Iso in all major assemblies, and wherever possible.**

Note: The study team found that there was a role for ZEB in creating local jobs and training opportunities through workforce initiatives. Advanced construction techniques with emerging technologies, such as heavy timber and panelized systems, will contribute to job growth and education. Labor commuting is also a highly significant factor in total carbon footprint of construction. Therefore, local labor can play a huge role in carbon reductions.

parametric energy modeling

To perform the analysis the team utilized parametric energy modeling, where many combinations of building approaches and features are rapidly and automatically tested by computer programs in order to help find the most energy-efficient and cost-effective combined strategies. Each typology was simulated with approximately 38,000 combinations of variables including envelope air-tightness, opaque envelope R-Values, window and glazing properties, ventilation system alternatives, heating/

cooling systems, and domestic hot water systems. The large-batch optimization studies used WUFI-Plus from Fraunhofer IBP, with the results post-processed and analyzed using Thornton Tomasetti's Design Explorer, an interactive and multi-dimensional data visualization tool that allowed the team to filter iterations for specific outcomes such as Coze footprint per person and operational utility cost.

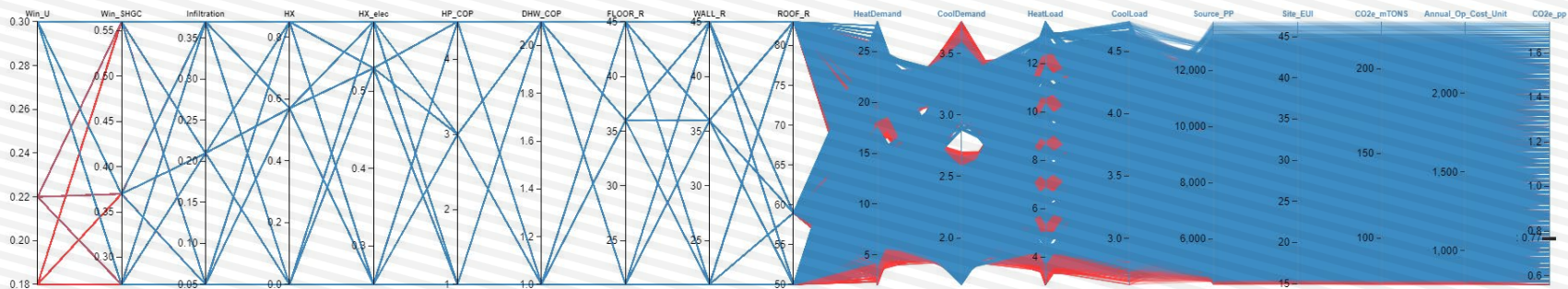

Each vertical line on the left in the image above represents a building characteristic (i.e. window u-value, air-tightness, heat pump C.O.P., wall R-value etc.)

Each vertical line on the right in the image above represents building energy use and CO2 emission based on each building characteristic (i.e. heat demand, cooling demand, site EUI, and CO2e per person)

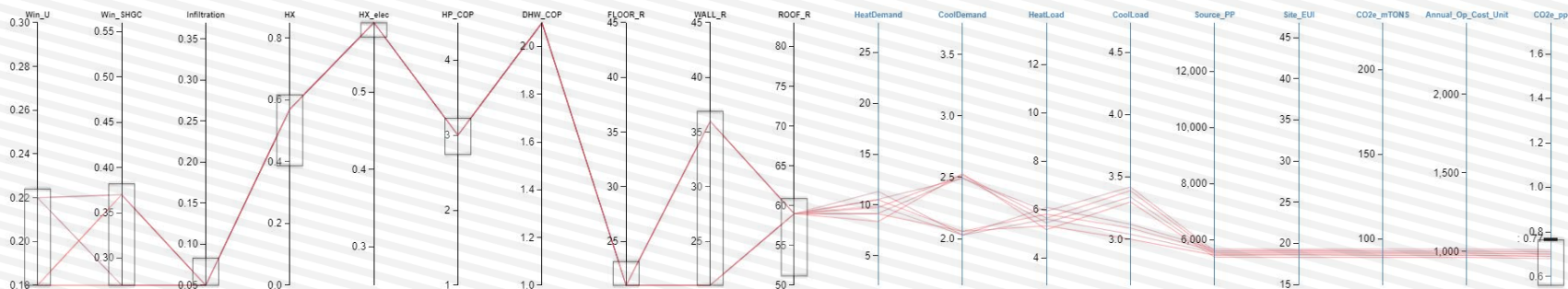

In the image above the CO2 emission for the building has been set to the 0.77 Coze per person target. The matrix above is generated and a series of building characteristics are selected based on cost and performance. The end result is the optimal combination of building characteristics to produce a Zero Emission Building.

building v portfolio

building by building approach

The first batch of simulations looked at each building individually and modeled assuming that the total energy demand of the building was offset by on-site renewable energy sources. Prior to modeling the assemblies, it was assumed that the larger building would perform better and the density of units would contribute to better performance overall.

However, the modeled assemblies heavily favored the smaller typologies. The larger typologies (5+ stories) simply had a larger energy demand due in part to the number of units (occupants). The roof areas are also not large enough to accommodate a significant enough photo voltaic (PV) array to produce the overall energy needs of the building.

The first batch of simulations found that as the energy demand of the building exceeds the roof/PV array area and thus PV energy production capacity, the building tips into not being able to offset all its energy needs on-site.

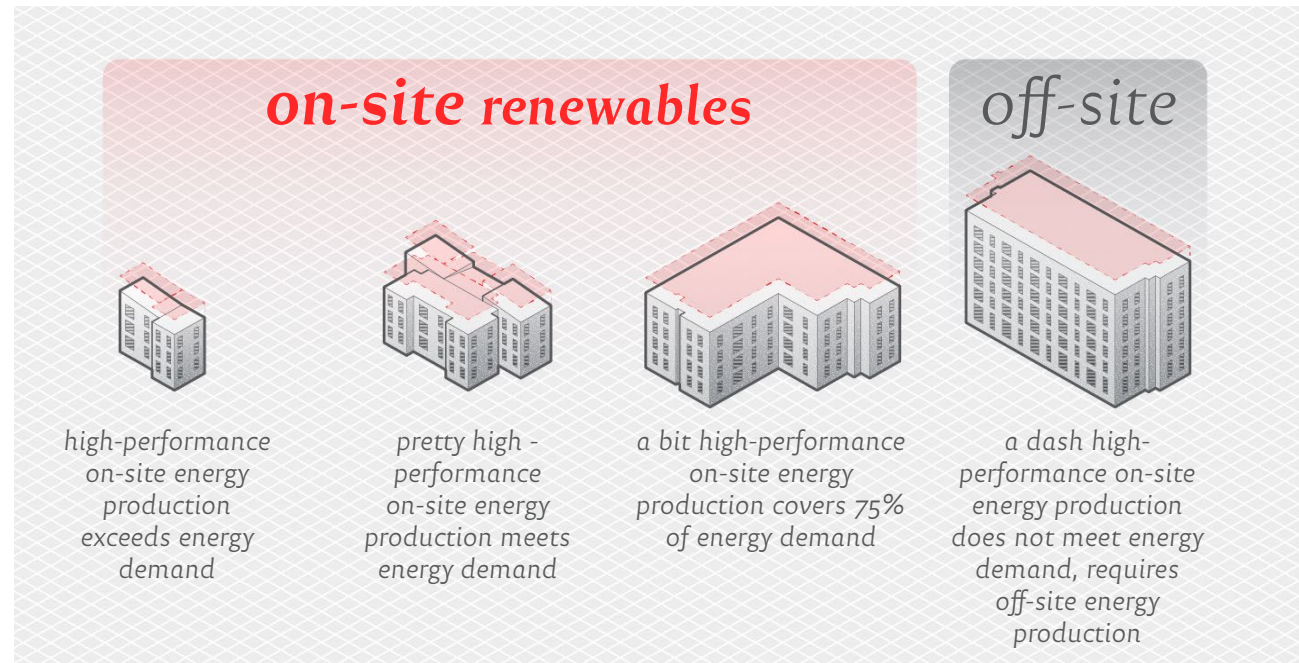

The building by building approach also supported the common notion that increasing the insulating values of the assemblies, especially in the 5+ story buildings, would eventually produce a building that would meet the zero emission goal. Modeling proved that this was not the case. Performance would be slightly better overall but the slight improvement did not justify the increased costs.

Therefore, as shown in the diagram above, the building by building approach favored the smaller typologies which did not require the building envelope criteria to be as strict as the building envelope criteria of the 5+ story building.

The team found that the need to have significant variation in the assemblies between small and mid-sized buildings was also a major weakness of this approach.

building v portfolio

portfolio approach

The second batch optimization rethought the building by building approach. A particular goal of this approach was to try to normalize the building criteria across typologies. Instead of one building, this batch analyzed a group of buildings or “a portfolio” of projects.

DND provided a list of projects expected to start construction by 2019. The portfolio consisted of approximately 4-6 projects from each typology. After estimating the total number of occupants, roof area, and the total energy production which could be generated, the optimization was used to see if the per person energy production could form the basis of zero emissions design criteria.

As you see in the diagram to the right, smaller buildings that can reach zero emissions and produce excess energy support larger buildings that use more energy. The portfolio approach budgeted Carbon per Person as an allowance of 0.77 Co2e.

the portfolio approach led to this outcome:

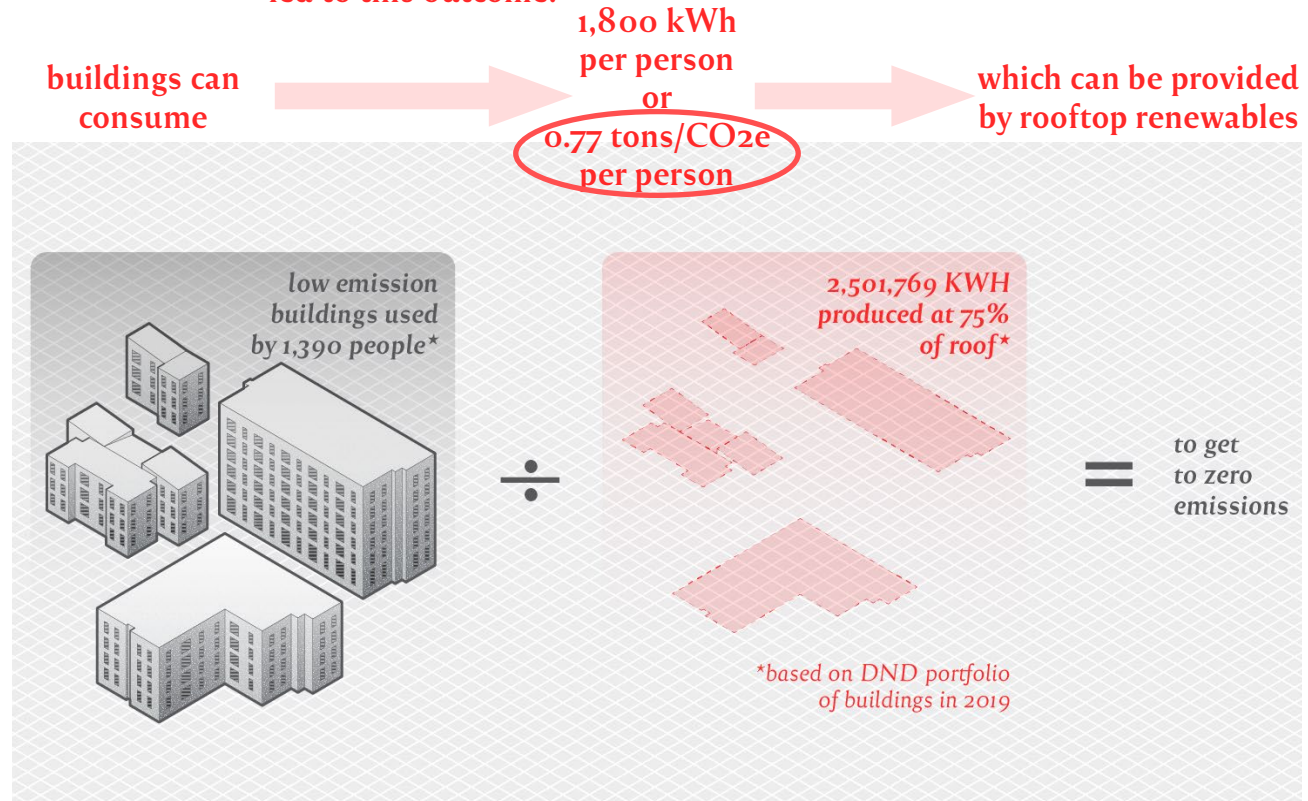

This aligned directly with the 2050 goals set forth by IEA and DOE/PHIUS for carbon reduction.

The same approach could also be applied to an entire neighborhood, city or region. From an urban perspective, this could assist city planners in determining zero emissions districts.

Of particular interest is to encourage local developers and property owners to apply the “portfolio” approach to a zero-emissions portfolio of their own, including new and existing buildings.

As seen in section 3, the portfolio approach allows both the smaller typologies and larger typologies to follow an analogous path to reach zero emissions through a carbon per person budget.

The DND portfolio allows for a 0.77 Co2e per person budget which equals 1800 kWh per person of on-site energy use.

building v portfolio

Further supporting the portfolio approach to reaching zero emissions, the top diagram shows how important it is for smaller buildings to actually be net energy positive. They generate excess power that larger buildings can not. The lower diagram illustrates the portfolio concept. Not all the buildings need to be Zero Emissions, but as a community of buildings are measured together the same outcome is reached.

Applying this approach of a carbon budget per person to existing buildings would be the first step in generating a Zero Emissions plan for the City as a whole.

In cities like Boston with dense housing, there is more opportunity for increasing efficiency when accounting for the entire urban fabric. Zero Emission Buildings are a key component to implementing a clean energy future.

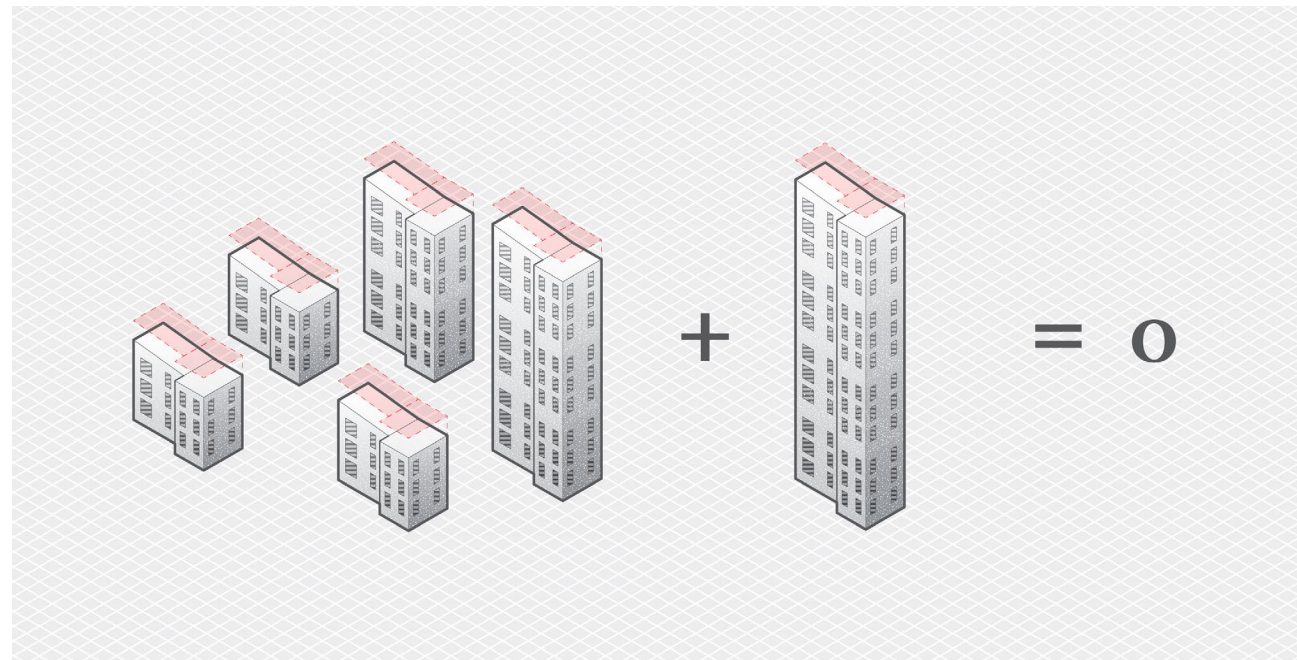
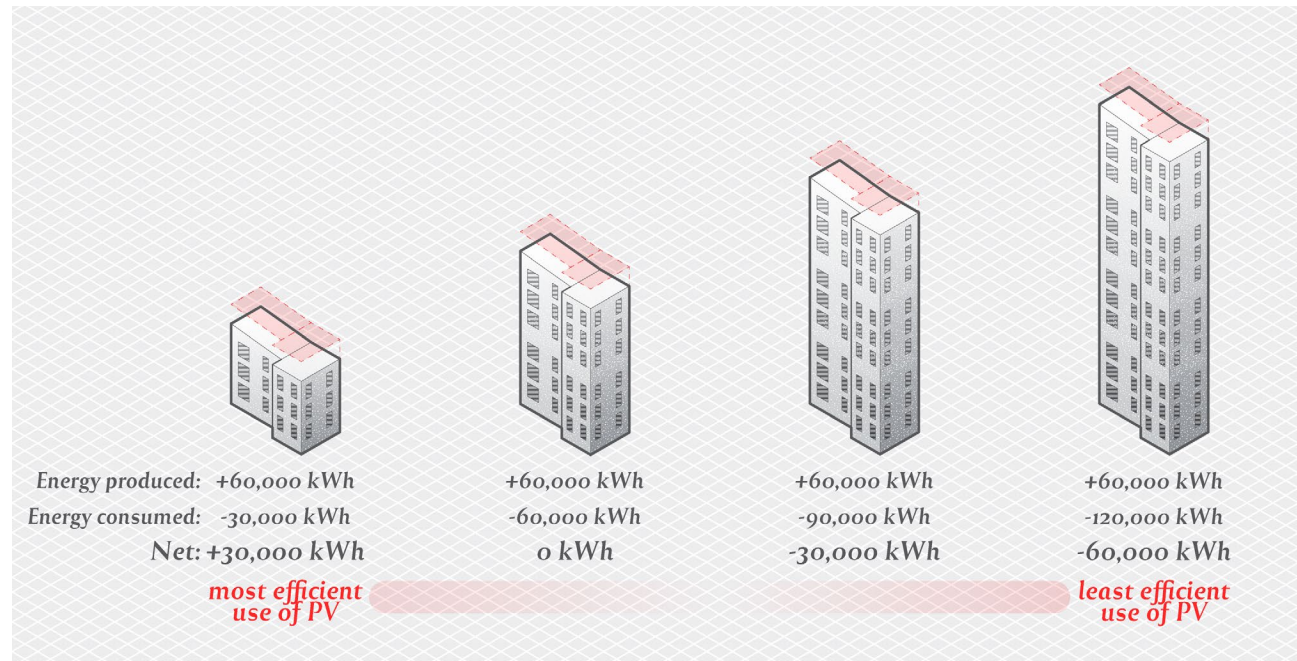

building elements - cost analysis

Overall performance was considered in direct relation to costs. The recommended assemblies and systems found in the case studies are modeled to be the most cost efficient for each typology.

Note: Alternative approaches can be found in the appendix. Typologies referenced there typically result in a higher building performance, often with a higher overall project cost.

- **Building Element Pricing** - includes material and labor costs.

- **Materials** - Boston metro area 2019 pricing. Material pricing is set either as Square Foot cost or Per Unit cost

- **Labor** - labor rates where applied were set to a flat burden rate per category

- **Systems** - system costs are per living unit / per square foot (ie - a six unit building would include 6 systems). The team established this criteria to enable direct comparative analysis amongst typologies. Stretch code systems account for efficient gas boilers/ furnaces, duct work, and a chiller for cooling. ZEB systems account for high efficiency air source heat pump systems with electric resistance aux. heat. The ZEB system cost is limited to a ductless system. The project team acknowledges future technology will impact performance criteria, increasing overall system performance.

- **Renewable** - Photovoltaic Costs: Turnkey Photovoltaic system costs do not the consider state and federal incentives available in Massachusetts. Renewable cost burdens can range from 0-100% depending upon the financial approach. Please refer to the Solar Massachusetts Renewable Target Program offered through DOER or similar programs offered by Mass CEC and Mass Save for more guidance.

- **Rebates and Incentives** - Current incentives and rebates were excluded from the cost analysis. Additional rebates are available through Mass Save and Mass CEC.

- **Windows** - Cost per unit, U- value, SHGC

Note: Cost is driven by economies of scale on a product basis.

- **Air tightness** - Cost per Project (includes labor + materials) **Airtightness plays an essential role in terms of overall building and insulation performance - see table below.**

Note: Current MA CMR requires all new construction to have air barriers and weather resistant barriers. As such the associated costs in achieving Zero Emission Building targets are based upon additional QA/QC at the Project Management level. A "leaky" R-30 wall WILL NOT perform the same as an air tight R30 wall.

Wall Framing Insulation	Continuous Insulation	Airtightness (ACH 050)	Heat Demand (kBtu/sf*yr)
2x6 w/ R-21	R-8	10	35
2x6 w/ R-21	R-8	3 (code)	24
2x6 w/ R-21	R-8	1	18

Note: The table above highlights a study done by 475 Performance Supply. Using the Passive House energy model, PHPP, the study displayed an overall reduction in heating demand by increasing air tightness overall.

building elements - cost analysis

- Heat Recovery Ventilation - Per project

The study indicated that whole system efficiency increases had very little impact in terms of overall project costs. Case studies indicated that the added overall cost could be avoided elsewhere.

- Domestic Hot Water Systems - Per unit

Pricing includes material cost and labor cost.

- Heating Systems - Per project

System design is specific to each individual project. Case studies indicated that through a confluence of avoided costs (eliminating natural gas service and distribution) there was a decrease in overall project by shifting to an all electric building.

- Roof R-Value - per Square Foot

Pricing includes material cost and labor cost.

- Walls R-Value - per Square Foot

Pricing includes material cost and labor cost. Case studies indicated that when estimating a double stud wall vs. continuous exterior insulation the labor was equal or less.

- Floor R-Value - per Square Foot

Pricing includes material cost and labor cost.

- Education and Labor -

QA/QC and commissioning requires training for Construction and Project Managers. Provide ZEB building operation training for facility managers and occupants. Explore opportunities to integrate Zero Emission Building training into the City of Boston's workforce development programs.

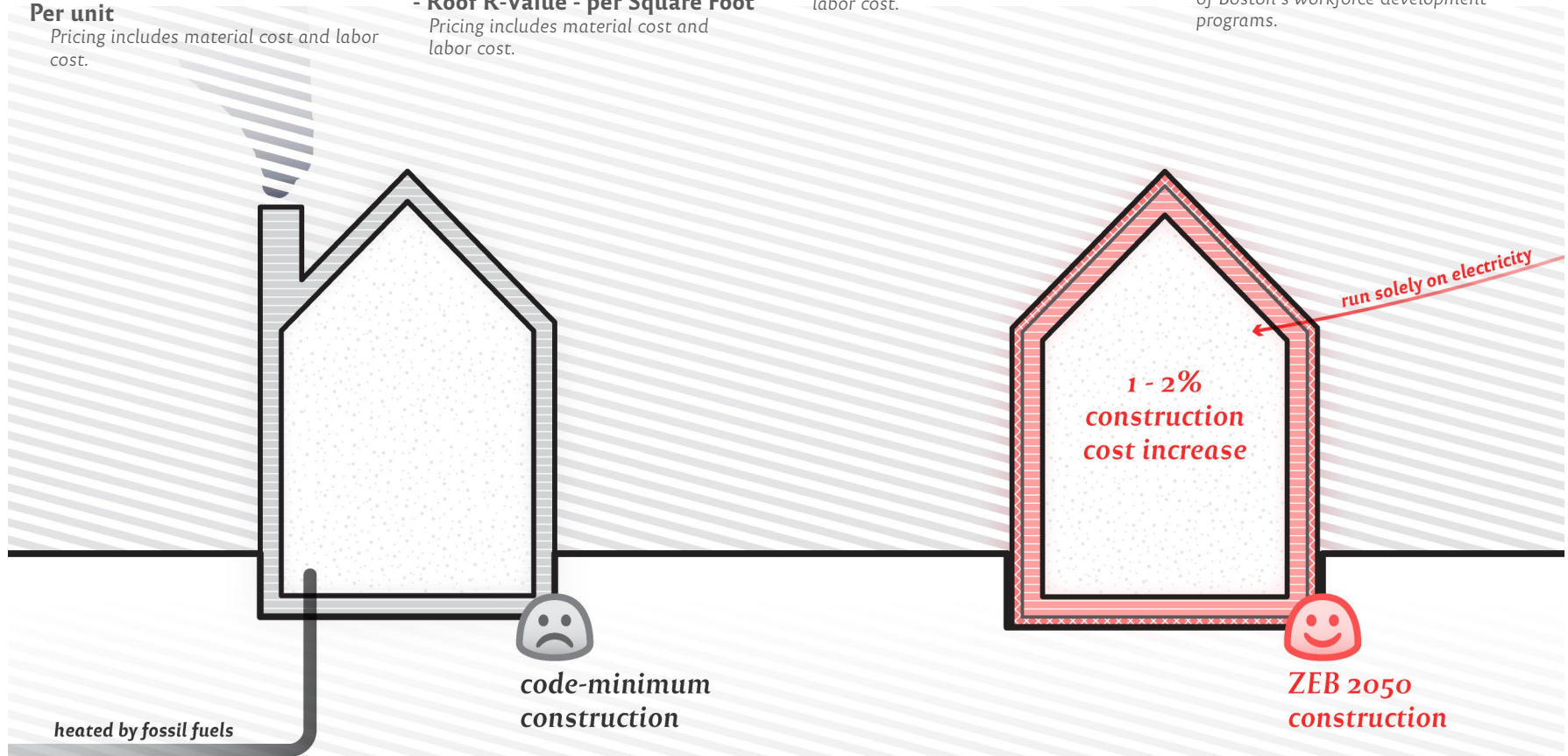

building elements and operation - cost analysis

	Small Multifamily 6 unit bldg	3 Story Multifamily 14 unit bldg	4 - 5 Story Multifamily 50 unit bldg	6 Story Multifamily 51 unit bldg
Stretch Code Baseline Building				
Stretch Code EUI (kBtu/sf/yr)	24	34.2	25.5	26.8
CO ₂ e / per person baseline Stretch Code (mTons/kwh)	0.86	1.19	0.8	0.82
Annual Utility Cost per living unit - 1.52 (dollar / therm)**	\$1,820	\$1,211	\$1,368	\$1,481
Stretch Code Baseline Build cost (\$)*	\$358,766	\$387,988	\$1,298,574	\$1,464,522
Zero Emission Building				
ZEB EUI (kBtu/sf/yr)	18	26	21	18
CO ₂ e / per person ZEB (mTons/kwh)	0.77	0.77	0.77	0.77
Annual Operational Cost per Unit ZEB - 22.61 (cents/kWh)	\$1,450	\$1,200	\$1,100	\$1,100
ZEB Baseline build cost (\$)*	\$361,913	\$390,312	\$1,310,419	\$1,496,920
Stretch Code vs ZEB				
Incremental Cost difference to ZEB (\$) Total project cost	\$3,148	\$2,324	\$11,845	\$32,398
Incremental Cost to ZEB (% increase)	0.88%	0.60%	0.91%	2.21%
Incremental change per person CO ₂ e ZEB (% decrease)	-25%	-24%	-18%	-33%
Incremental Cost difference to ZEB (% decrease) operational cost	-20%	-1%	-20%	-26%
Renewables - Rebates and Incentives are not included				
Solar PV size (kW) - 75% of Roof Areas	37 KW	40 KW	156 KW	104 KW
PV cost installed (Average \$3.16 / watt)	\$117,000	\$126,000	\$492,000	\$328,000

* Baseline cost is per modeled building component only (U-value, SHGC, Air-Tightness, Heat Recovery efficiency, Domestic Hot Water, Heating, Roof R, Walls R, Floor R)

** Stretch code operating cost - Operating costs based on 2018/2019 and 2019/2020 Mass DOER heating cost data
Plug loads were normalized based on DND occupant criteria (2 people per bedroom) for both Stretch code and ZEB operating costs

How to use this table:

Modeled categories are compared across each typology using stretch code as a baseline standard for energy use, carbon emissions and construction cost. The table highlights the benefits associated with Zero Emissions Buildings, energy and carbon reductions. The table also displays the incremental change associated with operational cost, construction cost and carbon reduction for the modeled building elements.

modeled results

note: See section 3 for building element recommendations per typology.

small multifamily

Components	Stretch Code 2019	Zero Emission Building
Window U-value	0.3	0.22 min.
Window SHGC	no requirement	0.3 min.
Window/Wall ratio	no requirement	11%
Airtightness (CFM ₅₀)	0.27 (3ACH)	0.06 min.
Heat Recovery %	no requirement	57% min.
DHW Systems	gas hot water	electric resistance
Heat Systems	heat pump w/ boiler	heat pump no fossil fuels
Roof R-value	R-49	R-60 min.
Walls R-value	R-20	R-36 min.
Floor R-value	R-10	R-21 min.
PV 75% roof area	no requirement	25 Kw
Construction cost	0%	0.88% increase
Operational cost	0%	20% decrease

3 story multifamily

Components	Stretch Code 2019	Zero Emission Building
Window U-value	0.3	0.22 min.
Window SHGC	no requirement	0.27 min.
Window/Wall ratio	no requirement	18%
Airtightness (CFM ₅₀)	0.27 (3ACH)	0.06 min.
Heat Recovery %	no requirement	57% min.
DHW Systems	gas	electric heat pump
Heating Systems	heat pump w/ boiler	heat pump no fossil fuels
Roof R-value	R-49	R-60 min.
Walls R-value	R-20	R-36 min.
Floor R-value	R-10	R-21 min.
PV 75% roof area	no requirement	40 Kw
Construction cost	0%	0.60% increase
Operational cost	0%	1% decrease

modeled results

note: See section 3 for building element recommendations per typology.

4 - 5 story multifamily

Components	Stretch Code 2019	Zero Emission Building
Window U-value	0.3	0.22 min.
Window SHGC	no requirement	0.3 min.
Window/Wall ratio	no requirement	20%
Airtightness (CFM ₅₀)	0.27 (3ACH)	0.06 min.
Heat Recovery %	no requirement	85% min.
DHW Systems	gas	electric heat pump
Heating Systems	heat pump w/ boiler	heat pump no fossil fuels
Roof R-value	R-49	R-60 min.
Walls R-value	R-26	R-36 min.
Floor R-value	R-10	R-21 min.
PV 75% roof area	no requirement	157 Kw
Construction cost	0%	0.91% increase
Operational cost	0%	20% decrease

6 story multifamily

Components	Stretch Code 2019	Zero Emission Building
Window U-value	0.3	0.22 min.
Window SHGC	no requirement	0.27 min.
Window/Wall ratio	no requirement	17%
Airtightness (CFM ₅₀)	0.27 (3ACH)	0.13 min.
Heat Recovery %	no requirement	65% min.
DHW Systems	gas	electric heat pump
Heating Systems	heat pump w/ boiler	heat pump no fossil fuels
Roof R-value	R-49	R-60 min.
Walls R-value	R-26	R-36 min.
Floor R-value	R-10	R-21 min.
PV 75% roof area	no requirement	104 Kw
Construction cost	0%	2.21% increase
Operational cost	0%	26% decrease

2

best practices for ZEBs

a | what is a ZEB?

b | key strategies

what is a ZEB?



A Zero Emission Building (ZEB) is designed so that the total amount of energy required for operation, and the energy used for the materials, are in line with a total CO₂e budget. For this study, the budget is based upon a portfolio of buildings, and a well-established per-person GHG footprint. (see section 1d for more explanation)

Prioritizes thermal bridge free / air tight construction

Prioritizes all electric systems and heat exchange ventilation

Prioritizes on-site renewable energy generation

Evaluates embodied of all materials

Includes off-site renewable energy / carbon offsets as necessary

DND's secondary approach is a Zero Emission Ready /Building. ZERBs are designed the same as a ZEBs but are considered "solar ready." A key parameter for a ZERB is to maintain a clear roof area free of any obstructions that would hinder PV installation. For example, a ZERB may only have 50-60% of the required photovoltaics to reach zero emissions and has the ability increase on site renewables overtime.

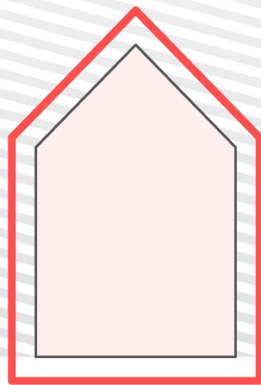

**thermal-bridge free +
optimized insulation**

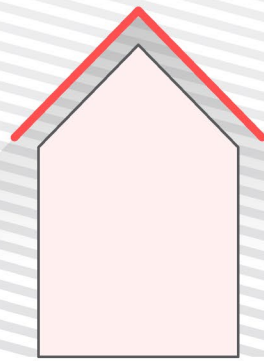

passive cooling

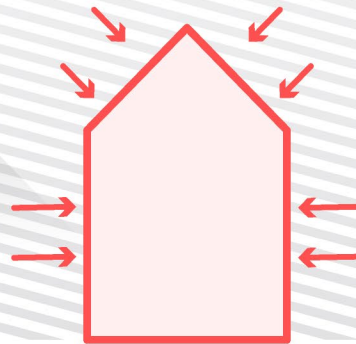

airtightness

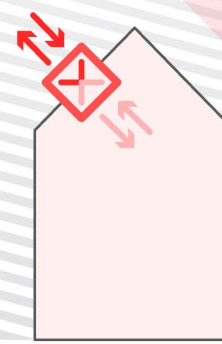

**heat exchange
ventilation**

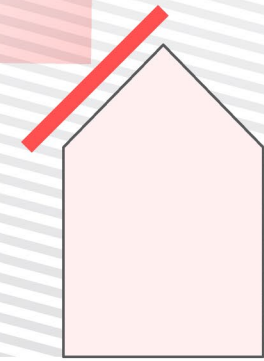

rooftop PV

key strategies

massing

During the early stages of the design process, massing should be prioritized. Massing can be thought of as a building's overall form, shape, and size in three dimensions. Simplified massing can help reduce heat loss from a building.

simplify form

The form of a building can have a tremendous effect on its performance. The more complex the building's shape, the harder it is to minimize heat loss through the envelope. A simple rectangle or cube with relatively few complex joints will retain far more heat.

maximize volume to surface

Massing can also be thought of in terms of the ratio of volume enclosed by the envelope to the surface area of that envelope. The more volume enclosed by less surface area the better performance the building will achieve.

enlarge floor plate

In general, smaller or narrower floor plates make performance targets harder to hit. By increasing a building's footprint and simplifying the shape, performance targets become easier to reach.



orientation

Orientation refers to how a building situates itself on-site in plan-view. By orienting their buildings carefully, professionals can reduce heating demands by as much as 30 - 40%. This strategy does not necessarily minimize heat loss, but it is a strategy to take advantage of passive heat gains.

take advantage of natural light

Thoughtful orientation can also reduce lighting loads through the use of natural light. Living spaces oriented toward the southwest enable inhabitants to use natural rather than artificial light.

maximize solar gains

Designers should orient the longest facade as close to due south as possible. The south-facing facade should be within 30° of due south. Many sites do not allow for this on all levels, but opportunities may exist to orient the upper floors due south.

avoid overheating

When using solar gain, care must be taken during summer months to avoid overheating. Designers can specify horizontal shading on the south side to mitigate overheating.

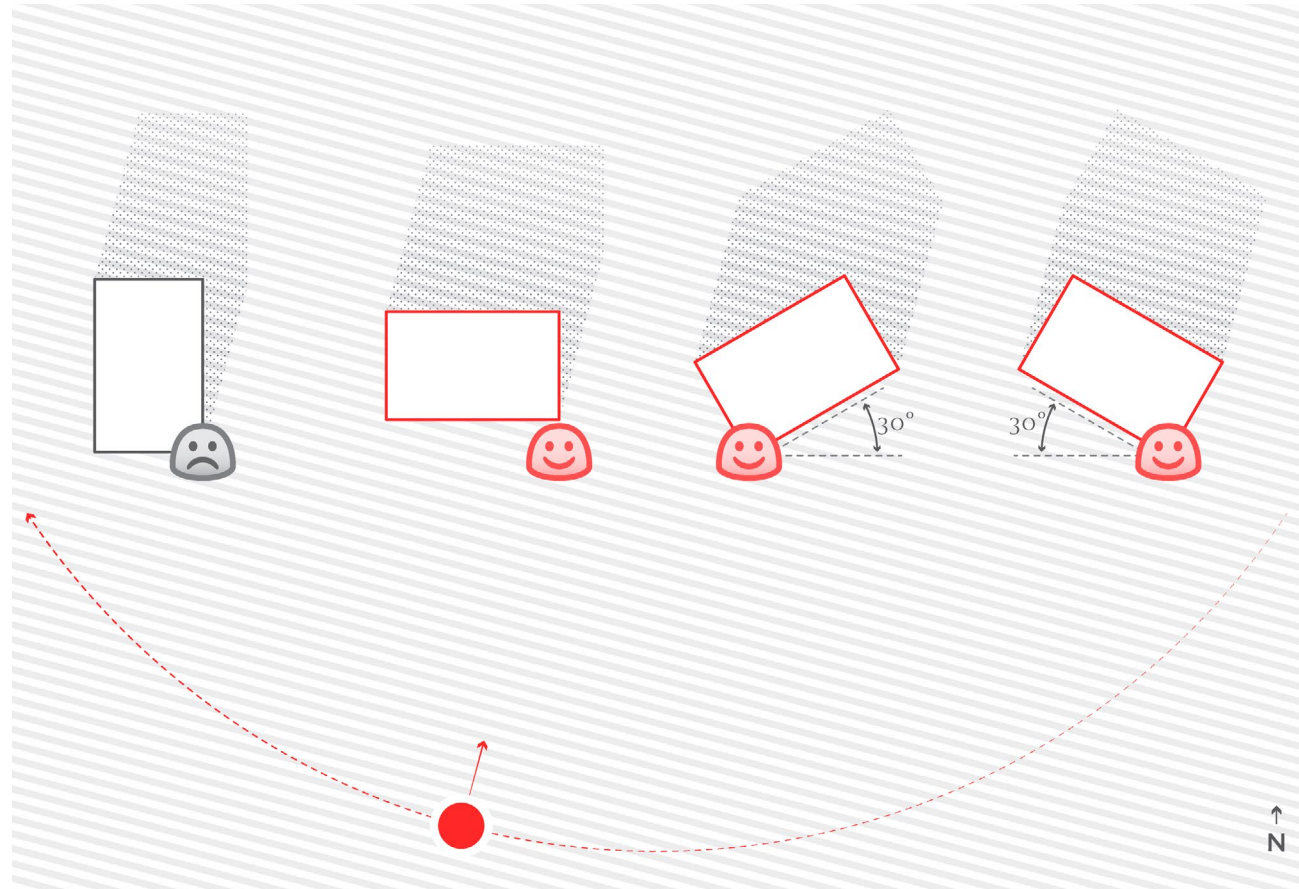

DND understands that many infill sites may not have the opportunity to align with this best practice due to neighborhood context or the orientation of the site itself.

impacts of unit density

The denser the ZEB the better. Maximizing the number of residences in a ZEB is a good approach for reducing energy consumption at an urban scale. The more people who live in energy efficient buildings like ZEBs, the fewer people who live in low performance buildings. At the scale of the city, the faster we move people from low performance buildings into high performance buildings the better.

An important note is that as unit density increases, the energy demand of the building also increases. This is OK because the energy use per resident decreases proportionally.

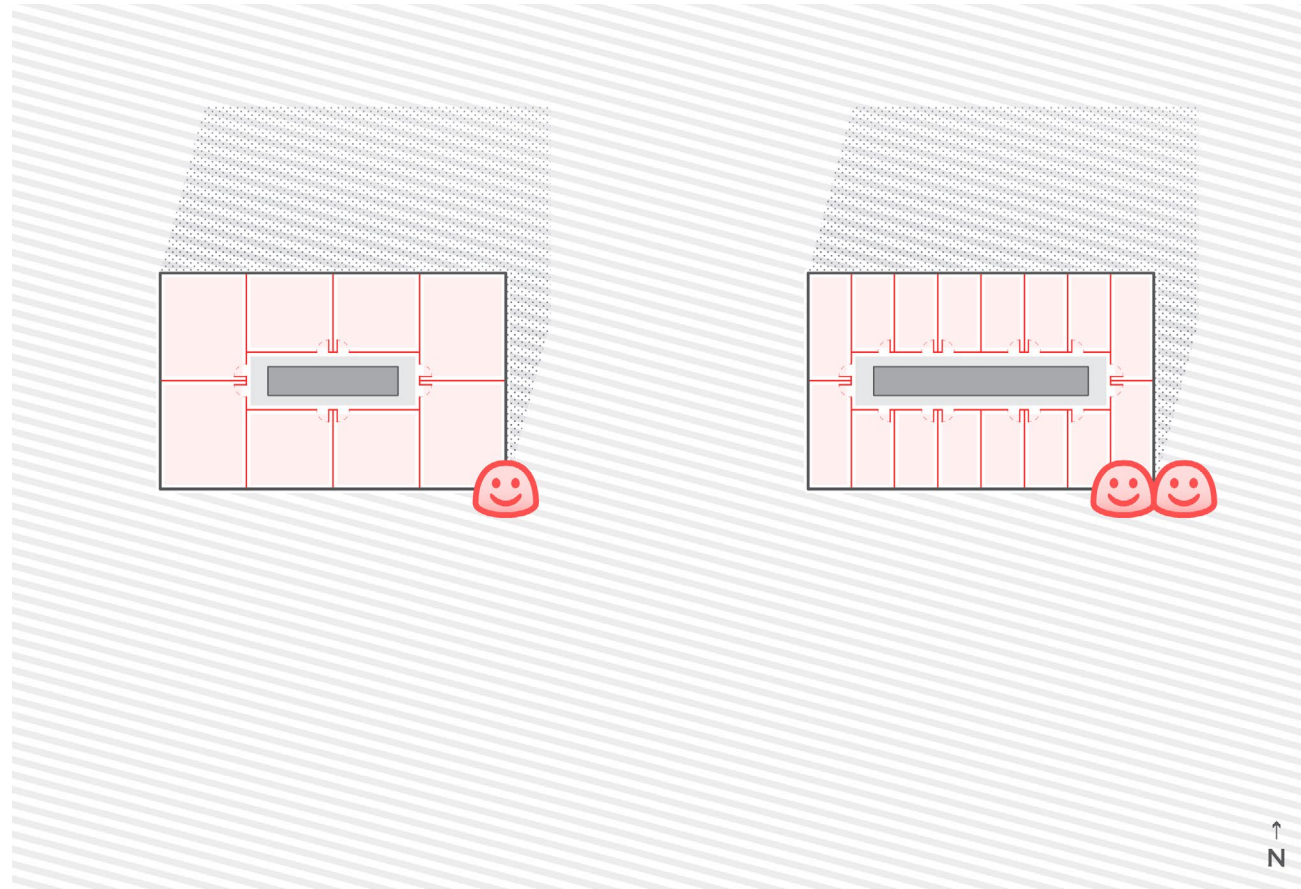

glazing percentages

Glazing percentages are important when minimizing heat loss, and controlling solar gains. It is important to optimize the glazing percentage based on the orientation of the window.

For south facades, aim for approximately 20% window area to wall area. 10 - 12% for east and west facades and 6 - 8% for north-facing facades.

Optimized Glazing strategies help to reduce cost, heat loss and excess solar gains. More windows require that the windows be higher-performance windows due to the amount of heat loss during the winter.



thermal bridging and r-value

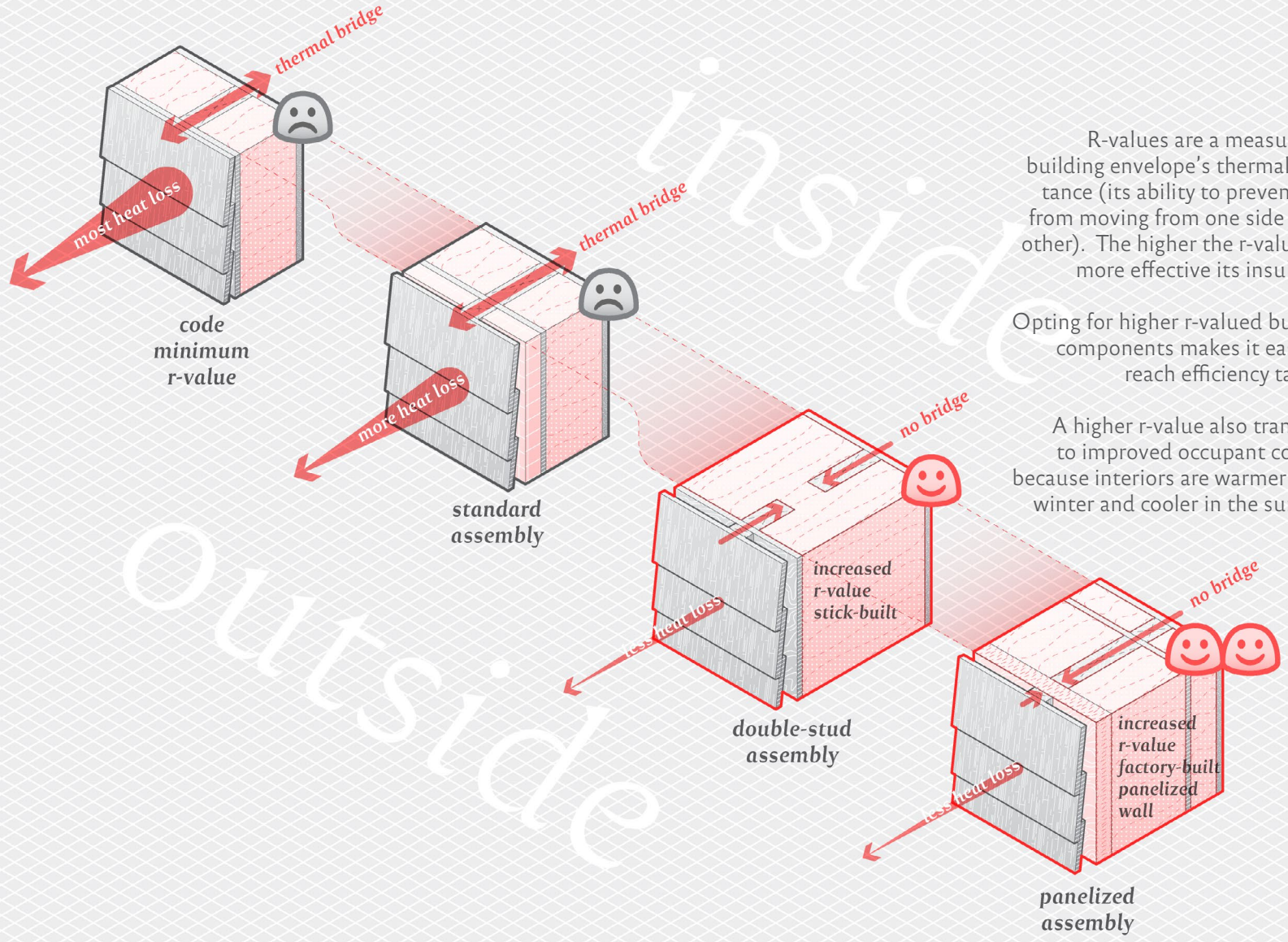

R-values are a measure of a building envelope's thermal resistance (its ability to prevent heat from moving from one side to the other). The higher the r-value, the more effective its insulation.

Opting for higher r-valued building components makes it easier to reach efficiency targets.

A higher r-value also translates to improved occupant comfort because interiors are warmer in the winter and cooler in the summer.

thermal bridging and r-value

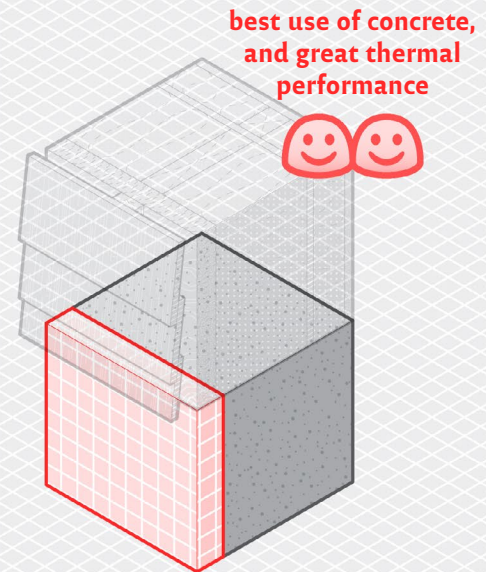
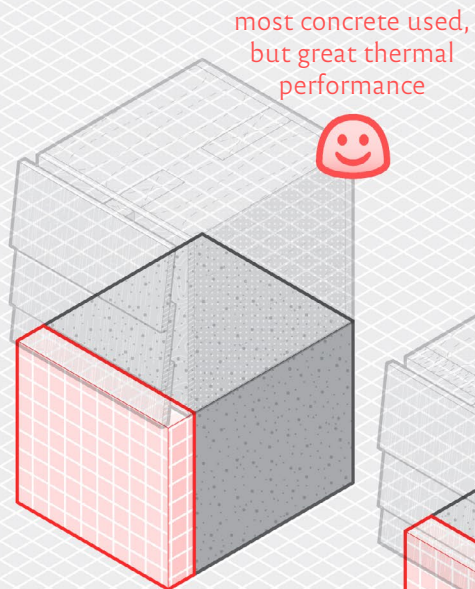
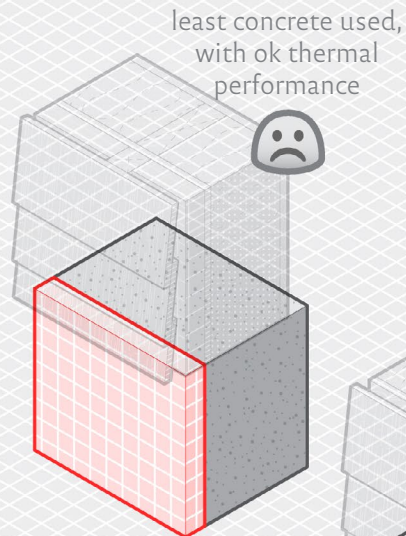
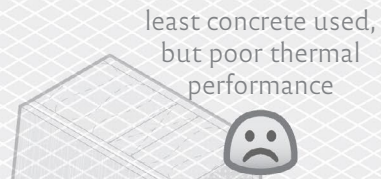

airtightness

Reaching an airtightness of 0.06 CFM₅₀ (passive house standard) is paramount to reducing a building's heating and cooling demands.

A simplified massing can help mitigate cost increases. More complex forms require more management and careful labor.

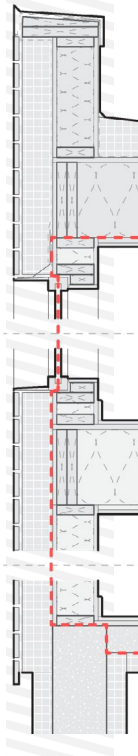

helpful to show air barrier in red

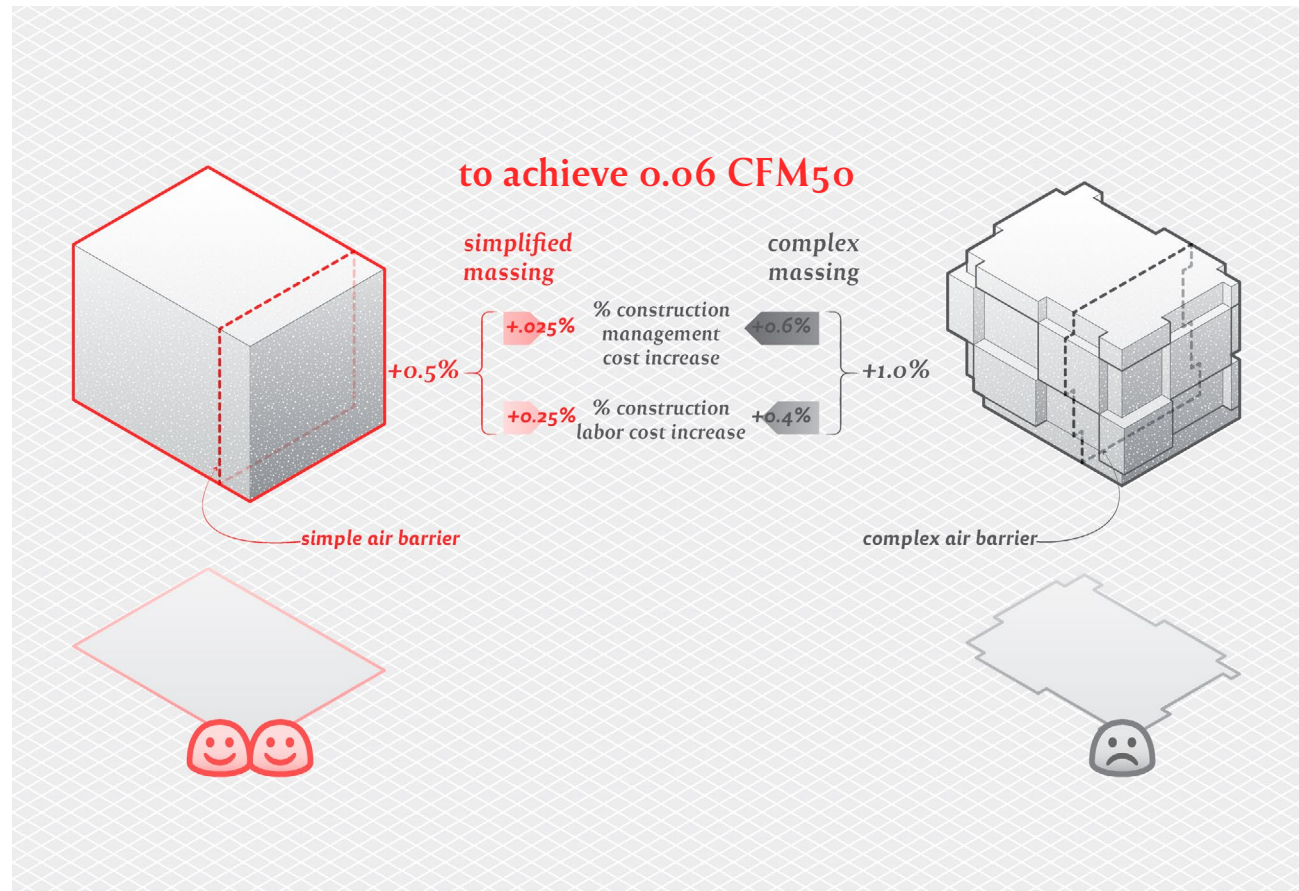

ventilation

Balanced systems HRV or ERV help channel tempered fresh air throughout the residence, increasing indoor air quality and moisture control. ERVs are recommended in Boston's climate zone.

It is advised that balanced ventilation systems are compartmentalized per dwelling unit

Increased indoor air quality (IAQ)

When used with a MERV filter, the system reduces allergens and common air pollutants. Excessive moisture is continuously removed from indoor spaces greatly reducing mold risks

Increased energy efficiency

(heat/ recovery - over heat loss typically found with exhaust only systems)

The more efficient the system the greater the savings in overall energy costs

Improved Health - stale, moist air is removed from the dwelling unit

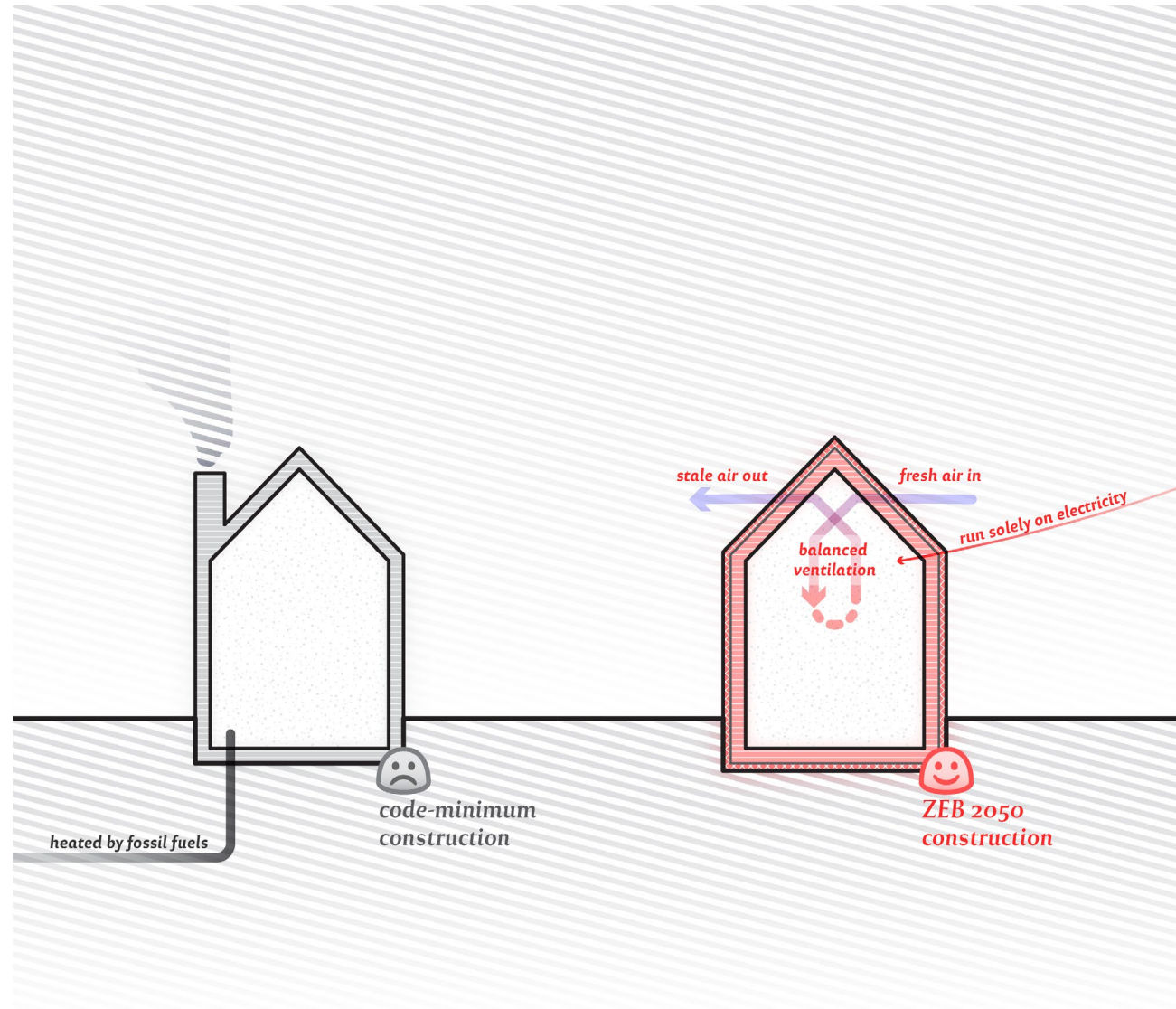

assembly summary

← meets stretch code minimums

→ meets ZEB minimums

barebones assembly

small multifamily only

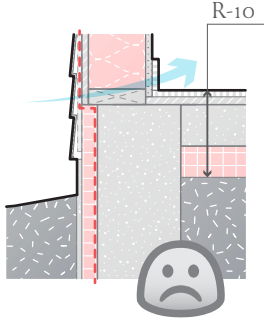
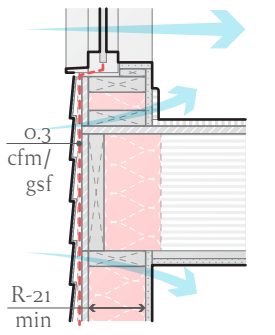
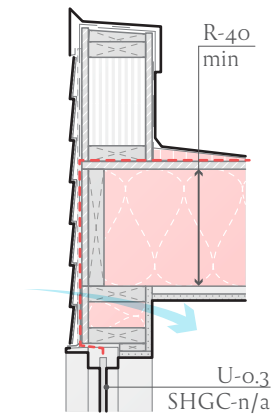

standard assembly

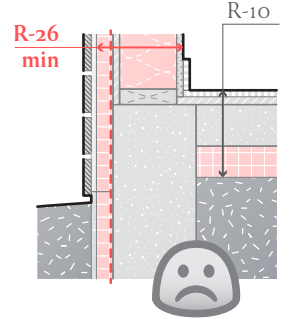
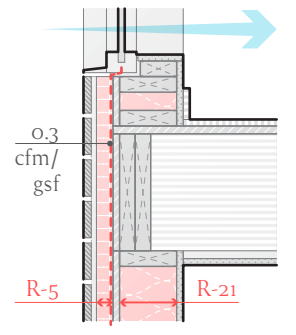
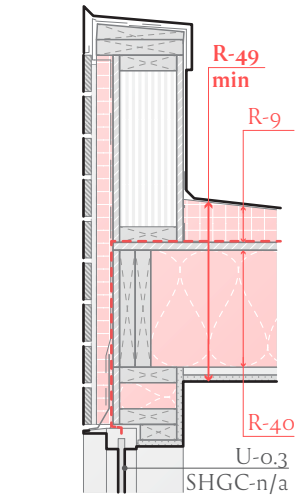

more efficient standard assembly

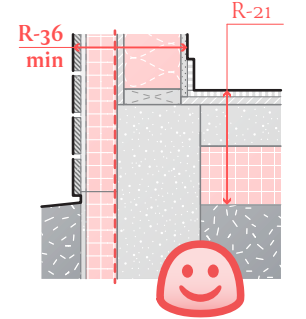
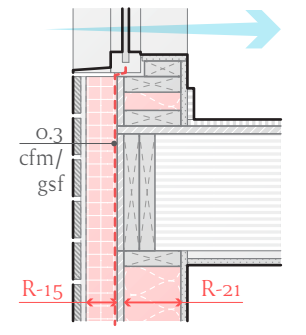
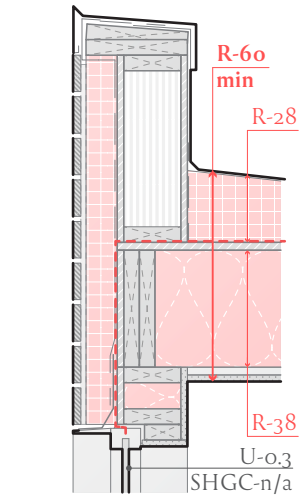

assembly summary



double-stud assembly

stick-built and cost-effective

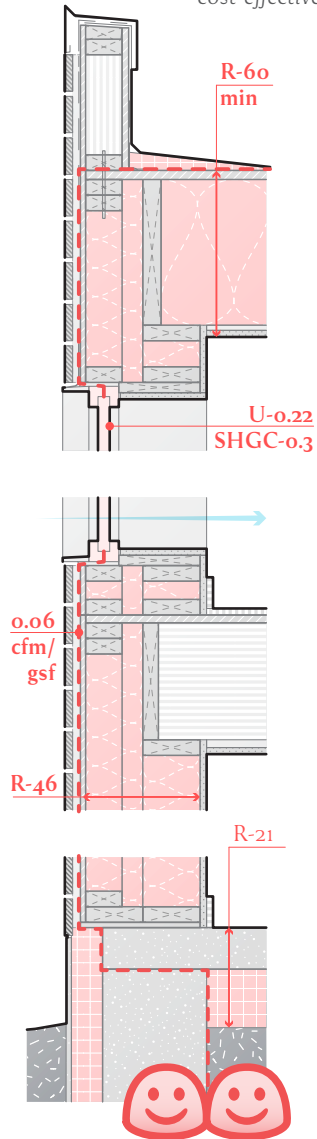

pre-fab panel assembly

improves schedule and performance

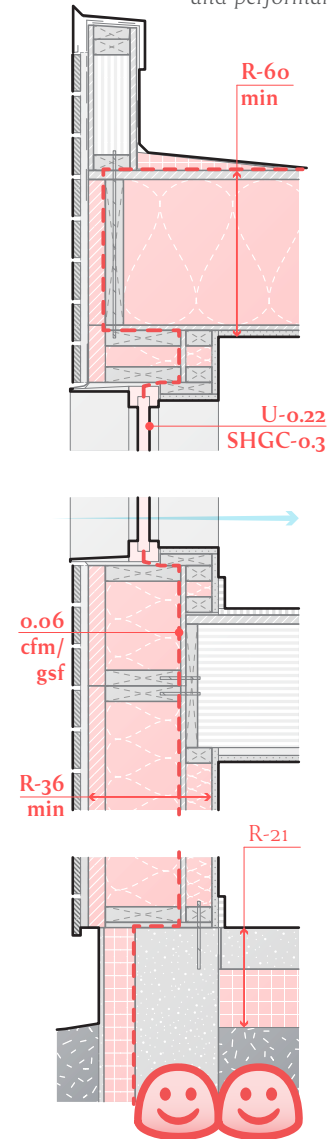

3 | typologies

a | introduction

b | small multifamily

c | 3 story multifamily

d | 4 - 5 story multifamily

e | 6 story multifamily

introduction

The case study results of each building typology are illustrated in section 3. This section provides a comparison of performance criteria, building components, and modeled assemblies for both a 2019 Stretch Code building and a Zero Emission Building. Located at the end of each typology section are both the recommended assemblies and the target ZEB design requirements for that typology.

Typologies:

small multifamily, 3 story multifamily, 4 - 5 story multifamily, 6 story multifamily

note: see page 10 for how these typologies were selected

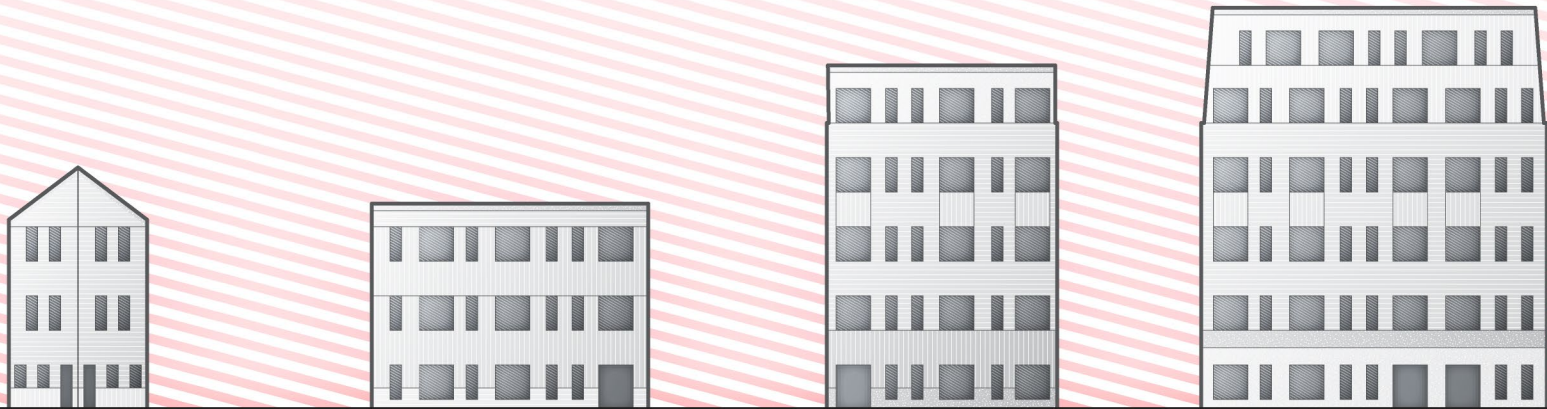

small multifamily



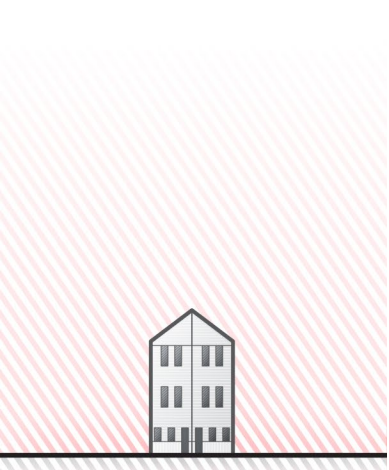

case study - results

Components	Stretch Code 2019	Zero Emission Building
Window U-value	0.3	0.22 min.
Window SHGC	no requirement	0.3 min.
Window/Wall ratio	no requirement	11%
Air-tightness (CFM ₅₀)	0.27 (3ACH)	0.06 min.
Heat Recovery %	no requirement	57% min.
DHW systems	gas hot water	electric resistance
Heating Systems	heat pump w/ boiler	heat pump no fossil fuels
Roof R-value	R-49	R-60 min.
Walls R-value	R-26	R-36 min.
Floor R-value	R-10	R-21 min.
PV 75% roof area	no requirement	25 Kw
Incremental Construction Cost	0%	0.88% increase
Incremental Operational Cost	0%	20% decrease

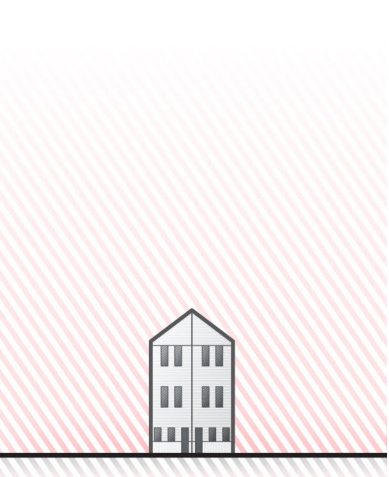

case study - assemblies

Stretch Code Building - Modeled Assemblies:

- Windows: Low E2 - 0.30 U-value
- Glazing: Clear Glazing SGHC 0.27
- Air Tightness: ACH 0.27 CFM/ SF (code 3.0 ACH)
- Heat Recovery: no requirement
- Domestic HW: 80 gal. Hot Water Tank
- Heating System: Heat pump condenser + Boiler 2.8 COP
- Roof: 10" Joist w Sheathing with R-30 Cavity Insulation + R-24.5 Continuous Board - R50
- Wall: 2x6 wood framed wall + R-21 Cavity Insulation + R-5 Continuous Board
- Floor: Slab on grade w/ R-10 continuous insulation
- Photovoltaics: no requirement

Zero Emission Building - Modeled Assemblies:

- Windows: Triple pane - 0.22 U-value
- Glazing: Clear 0.30 SHGC
- Air Tightness: ACH 0.06 CFM /SF
- Heat Recovery: HRV 57% efficiency - 0.77
- Domestic HW: Heat pump hot water - 2.1 COP
- Heating System: Heat pump 1 ton system - ductless - 3.0 COP
- Roof: 12" Joist w/ Sheathing with R-38 Cavity Insulation + R-28 Continuous Board - R60
- Wall: 2x6 wood frame wall + R-21 Cavity Insulation + R-15 Continuous Board
- Floor (Basement): Slab on grade w/ R-21 continuous insulation
- Photovoltaics: 25 Kw array

Note: For the sake of this study the project team modeled building products currently available on the market. Manufacturer names have been withheld.

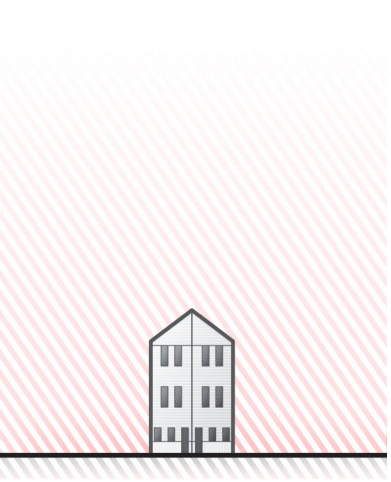

case study - assemblies

meets ZEB recommendations

modeled stretch assembly

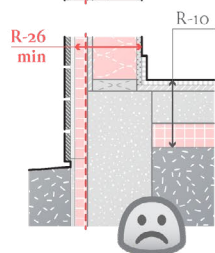
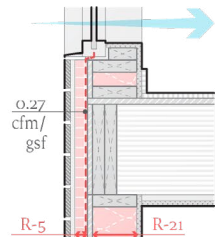
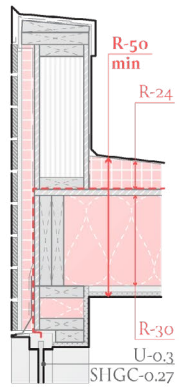

meets ZEB recommendations

modeled ZEB assembly

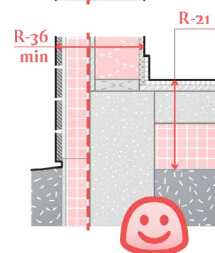
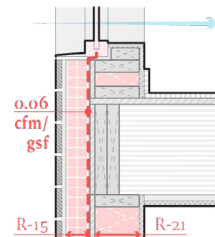
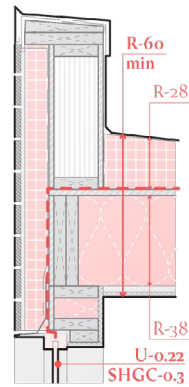

exceeds ZEB recommendations

double-stud assembly

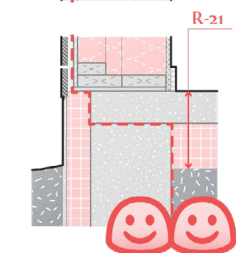
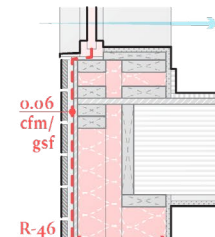
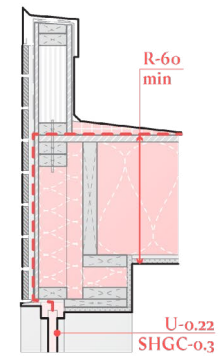

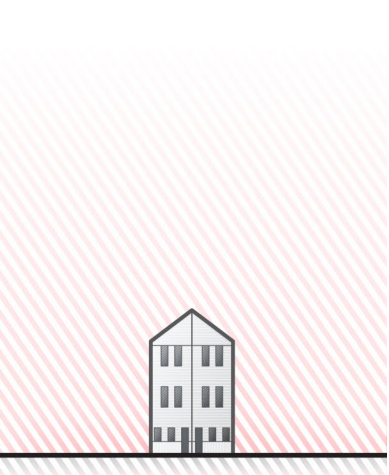

case study - massing



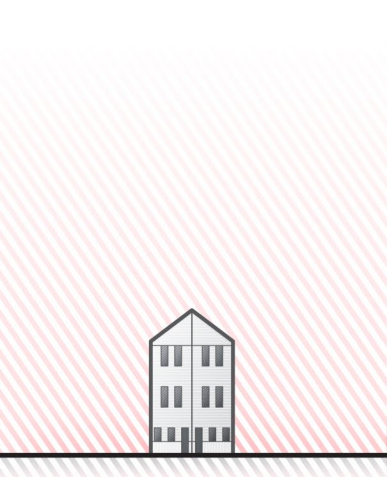

case study - orientation

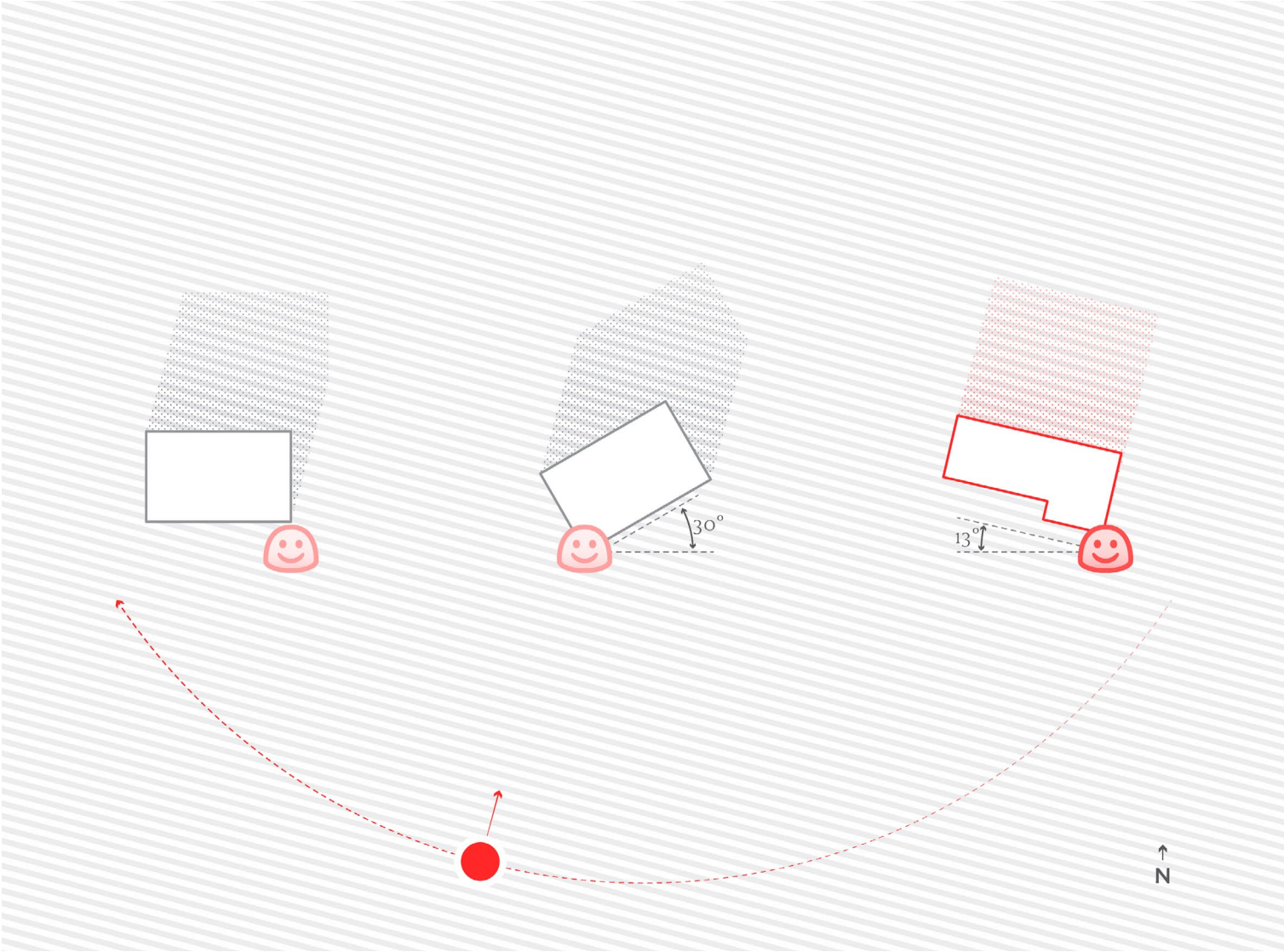

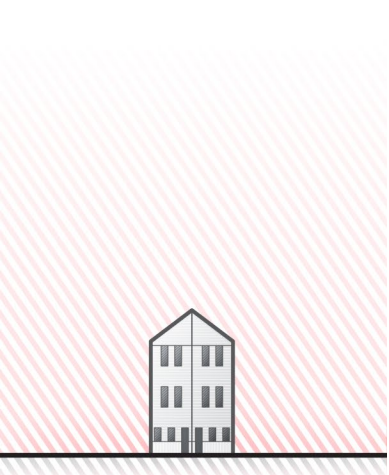

case study - glazing

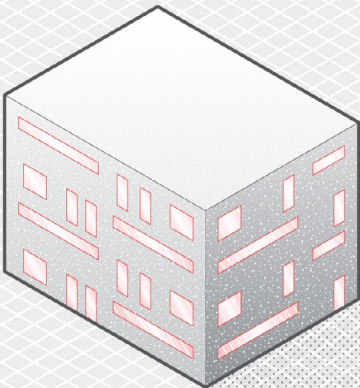

Window to Wall Ratio

11% of total surface
Window Specification
70 mm Upvc Tilt / Turn
U-value = 0.22
SHGC = 0.3

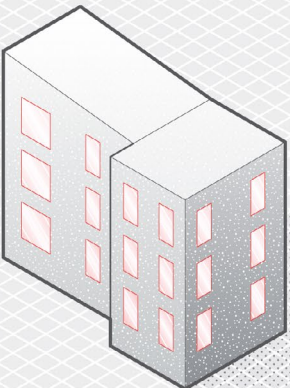

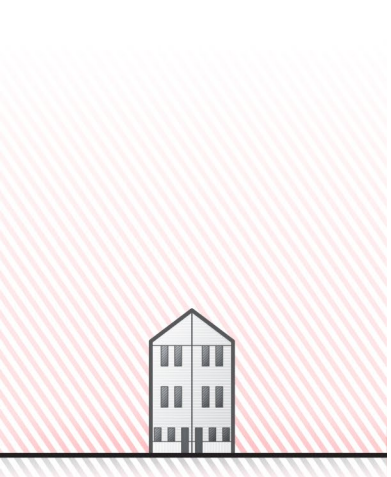

case study - airtightness

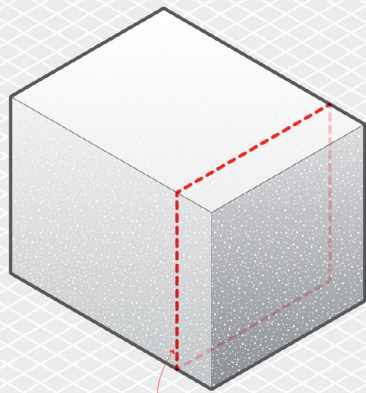

simple air barrier

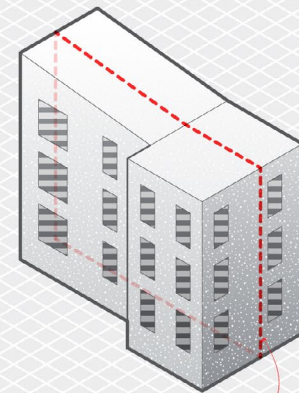

simple air barrier





recommendations

Thermal bridge free shell

Window to wall ratio = <15% (total surface area)

**Increased WWR above 15% results in a triple glazed window
0.18 u-value is recommended**

Window u-value 0.22

Window performance criteria = Energy Star Air Leakage <0.3
cfm/ft² @ 75 pascals

**Building Air tightness = 0.06 ACH cfm /sf² of gross envelope
area @ 50 pascals**

Heat pump DHW - 2.1 COP

Heat recovery ventilation - 57% + 0.77 watts per CFM

R60 roof, R36 wall, R21 Slab

-

3 story multifamily



case study - results



Components	Stretch Code 2019	Zero Emission Building
Window U-value	0.3	0.22 min.
Window SHGC	no requirement	0.27 min.
Window/Wall ratio	no requirement	18%
Air-tightness (CFM ₅₀)	0.27 (3ACH)	0.06 min.
Heat Recovery %	no requirement	57% min.
DHW systems	gas	electric heat pump hot water
Heating Systems	heat pump w/ boiler	heat pump no fossil fuels
Roof R-value	R-49	R-60 min.
Walls R-value	R-26	R-36 min.
Floor R-value	R-10	R-21 min.
PV 75% roof area	no requirement	40 Kw
Incremental Construction Cost	0%	0.60% increase
Incremental Operational Cost	0%	1% decrease

case study - assemblies



Stretch Code Building - Modeled Assemblies:

- Windows: Low E - 0.30 U-value
- Glazing: Clear SGHC 0.27
- Air Tightness: ACH 0.27 CFM/ SF (code 3.0 ACH)
- Heat Recovery: no requirement
- Domestic HW: 80 gal. Hot water tank
- Heating System: Heat pump condenser + Boiler 2.8 COP
- Roof: 10" Joist w Sheathing with R-30 Cavity Insulation + R-24.5 Continuous Board - R50
- Wall: 2x6 wood framed wall + R-21 Cavity Insulation + R-5 Continuous Board
- Floor: Slab on grade w/ R-10 continuous insulation
- Photovoltaics: no requirement

Zero Emission Building - Modeled Assemblies:

- Windows: Triple pane uPVC- 0.22 U-value
- Glazing: Clear 0.35 SHGC
- Air Tightness: ACH 0.06 CFM /SF
- Heat Recovery: ERV 57% Efficiency - 0.77 watts /cfm
- Domestic HW: Heat pump hot water 2.7 COP
- Heating System: Heat pump 1 ton system - ductless - 3.0 COP
- Roof: 12" Joist w Sheathing with R-38 Cavity Insulation + R-28 Continuous Board - R60
- Wall: 2x6 wood framed wall + R-21 Cavity Insulation + R-15 Continuous Board
- Floor (Basement): Slab on grade w/ R-21 continuous insulation
- Photovoltaics: 40 Kw array

Note: For the sake of this study the project team modeled building products currently available on the market. Manufacturer names have been withheld.

case study - assemblies



meets ZEB recommendations

modeled stretch assembly

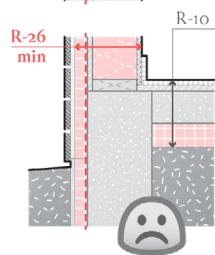
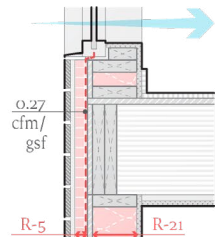
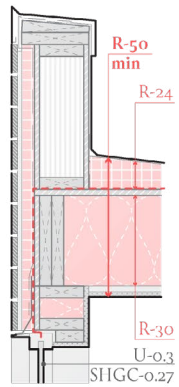

meets ZEB recommendations

modeled ZEB assembly

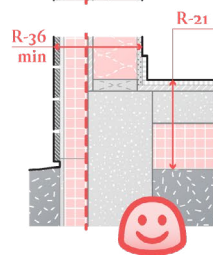
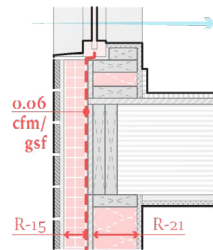
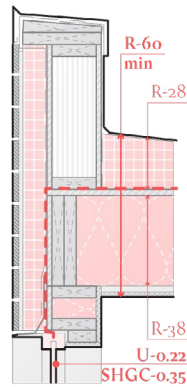

exceeds ZEB recommendations

double-stud assembly

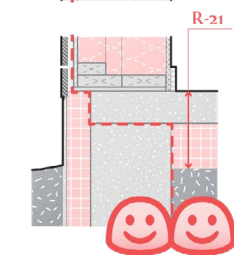
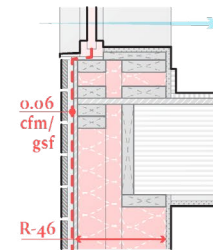
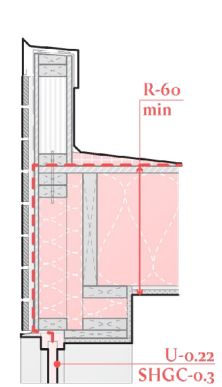

case study - massing

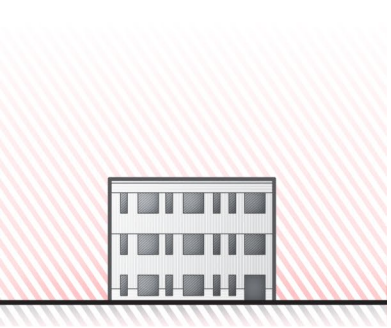

case study - orientation

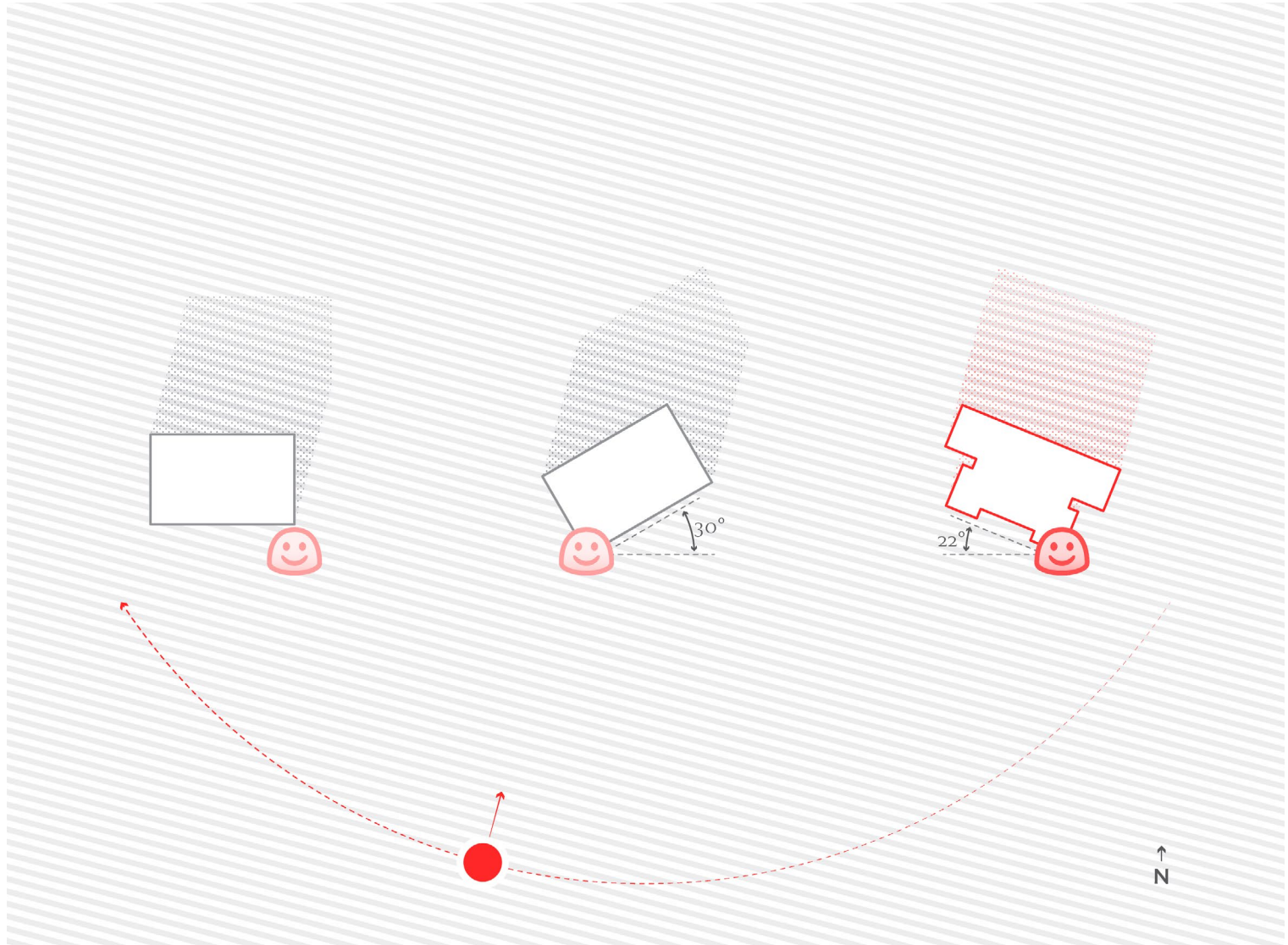
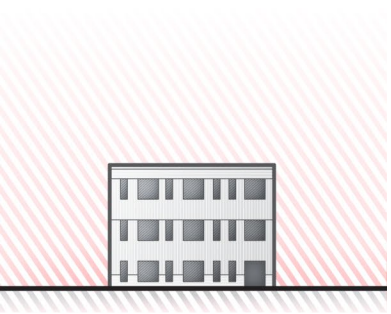

case study - glazing

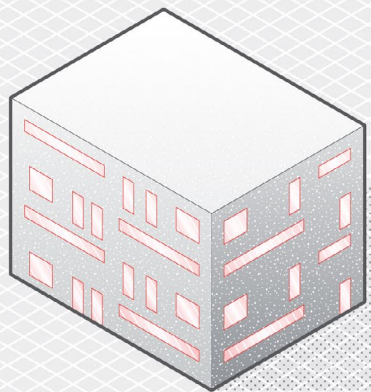
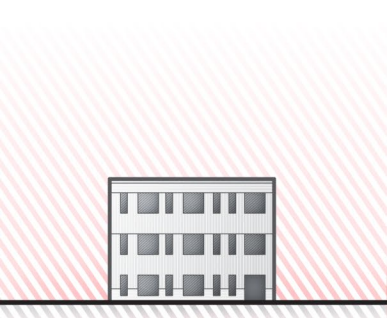

Window to Wall Ratio
18% of total surface
Window Specification
70 mm Upvc Tilt / Turn
U-value = 0.22
SHGC = 0.27

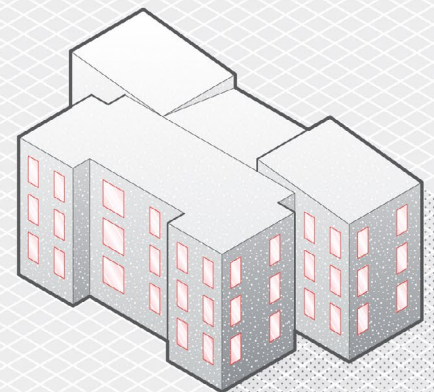

case study - airtightness

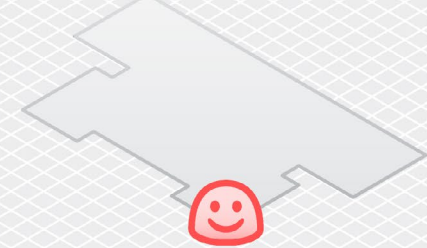
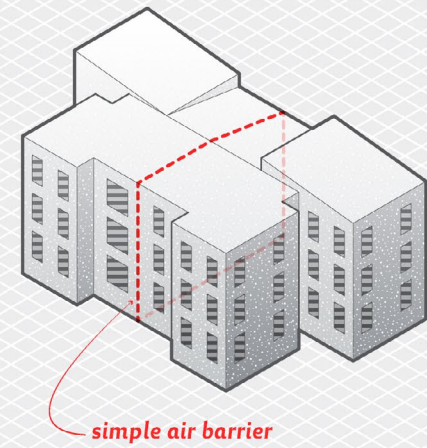
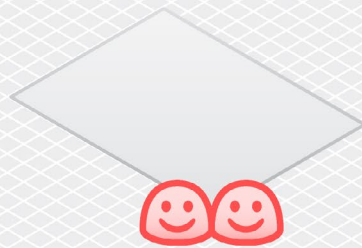
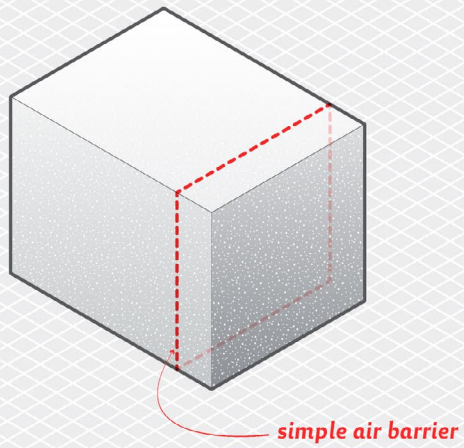
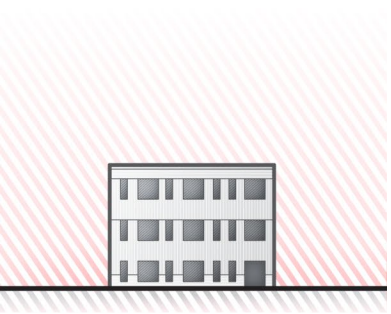

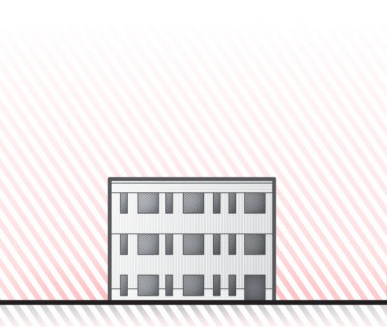

recommendations

Thermal bridge free shell

Window to wall ratio = <20% (total surface area)

**Increased WWR above 20% results in a triple glazed window
0.18 u-value is recommended**

Window u-value 0.22

Window performance criteria = Energy Star Air Leakage <0.3
cfm/ft² @ 75 pascals

**Building Air tightness = 0.06 ACH cfm /sf² of gross envelope
area @ 50 pascals**

DHW- 1 COP (electric resistance)

Heat recovery ventilation 57% + 0.77 watts /cfm

R6o roof, R36 wall, R21 Slab

4 - 5 story
multifamily

case study - results

Components	Stretch Code 2019	Zero Emission Building
Window U-value	0.3	0.22 min.
Window SHGC	no requirement	0.3 min.
Window/Wall ratio	no requirement	20%
Air-tightness (CFM ₅₀)	0.27 (3ACH)	0.06 min.
Heat Recovery %	no requirement	85% min.
DHW systems	gas	electric heat pump hot water
Heating Systems	heat pump w/ boiler	heat pump no fossil fuels
Roof R-value	R-49	R-60 min.
Walls R-value	R-26	R-36 min.
Floor R-value	R-10	R-21 min.
PV 75% roof area	no requirement	157 Kw
Incremental Construction Cost	0%	0.91% increase
Incremental Operational Cost	0%	20% decrease

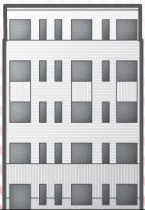

case study - assemblies

Stretch Code Building - Modeled Assemblies:

- Windows: Low E- 0.30 U-value
- Glazing: Clear - SGHC 0.27
- Air Tightness: ACH 0.27 CFM/ SF (code 3.0 ACH)
- Heat Recovery: no requirement
- Domestic HW: 80 gal. Hot Water Tank
- Heating System: Heat pump condenser + Boiler 2.8 COP
- Roof: 10" Joist w Sheathing with R-30 Cavity Insulation + R-24.5 Continuous Board - R50
- Wall: 2x6 wood framed wall + R-21 Cavity Insulation + R-5 Continuous Board
- Floor: Slab on grade with continuous R-10 insulation
- Photovoltaics: no requirement

Zero Emission Building - Modeled Assemblies:

- Windows: Triple pane - 0.28 U-value
- Glazing: Clear - 0.30 SHGC
- Air Tightness: ACH 0.06 CFM /SF
- Heat Recovery: ERV - 85% Efficiency - 0.77 Watts/cfm
- Domestic HW: Heat pump hot water 2.1 COP
- Heating System: Heat pump 1 ton system - ductless - 3.0 COP
- Roof: 10" Joist w Sheathing with R-38 Cavity Insulation + R-28 Continuous Board - R60
- Wall: 2x6 wood framed wall + R-21 Cavity Insulation + R-15 Continuous Board - R36
- Floor (Basement): Slab on grade w/ R-21 continuous insulation
- Photovoltaics: 157 Kw array

Note: For the sake of this study the project team modeled building products currently available on the market. Manufacturer names have been withheld.

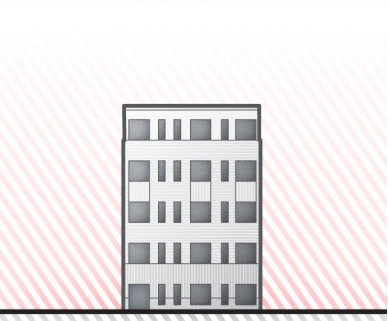

case study - assemblies

meets ZEB recommendations

modeled stretch assembly

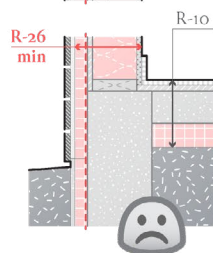
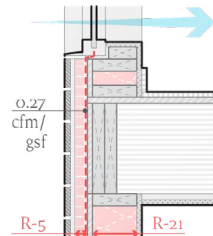
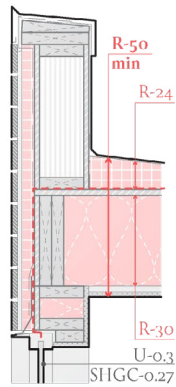

meets ZEB recommendations

modeled ZEB assembly

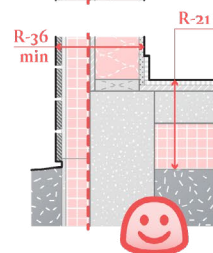
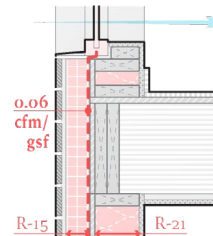
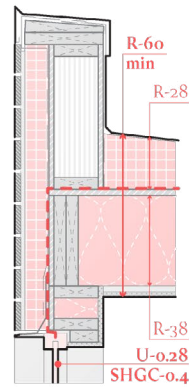

exceeds ZEB recommendations

pre-fab panel assembly

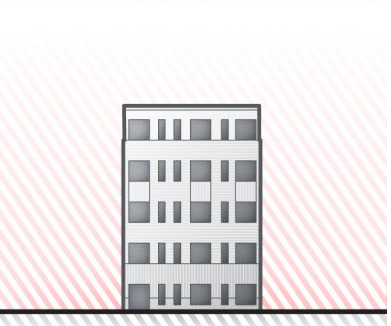
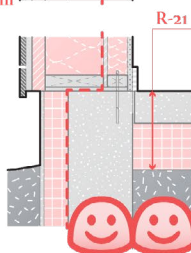
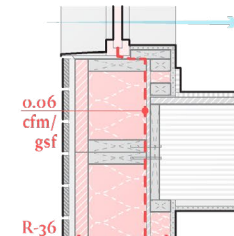
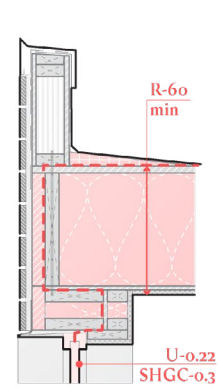

case study - massing

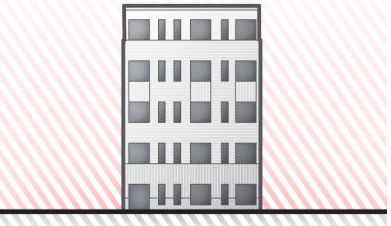

case study - orientation

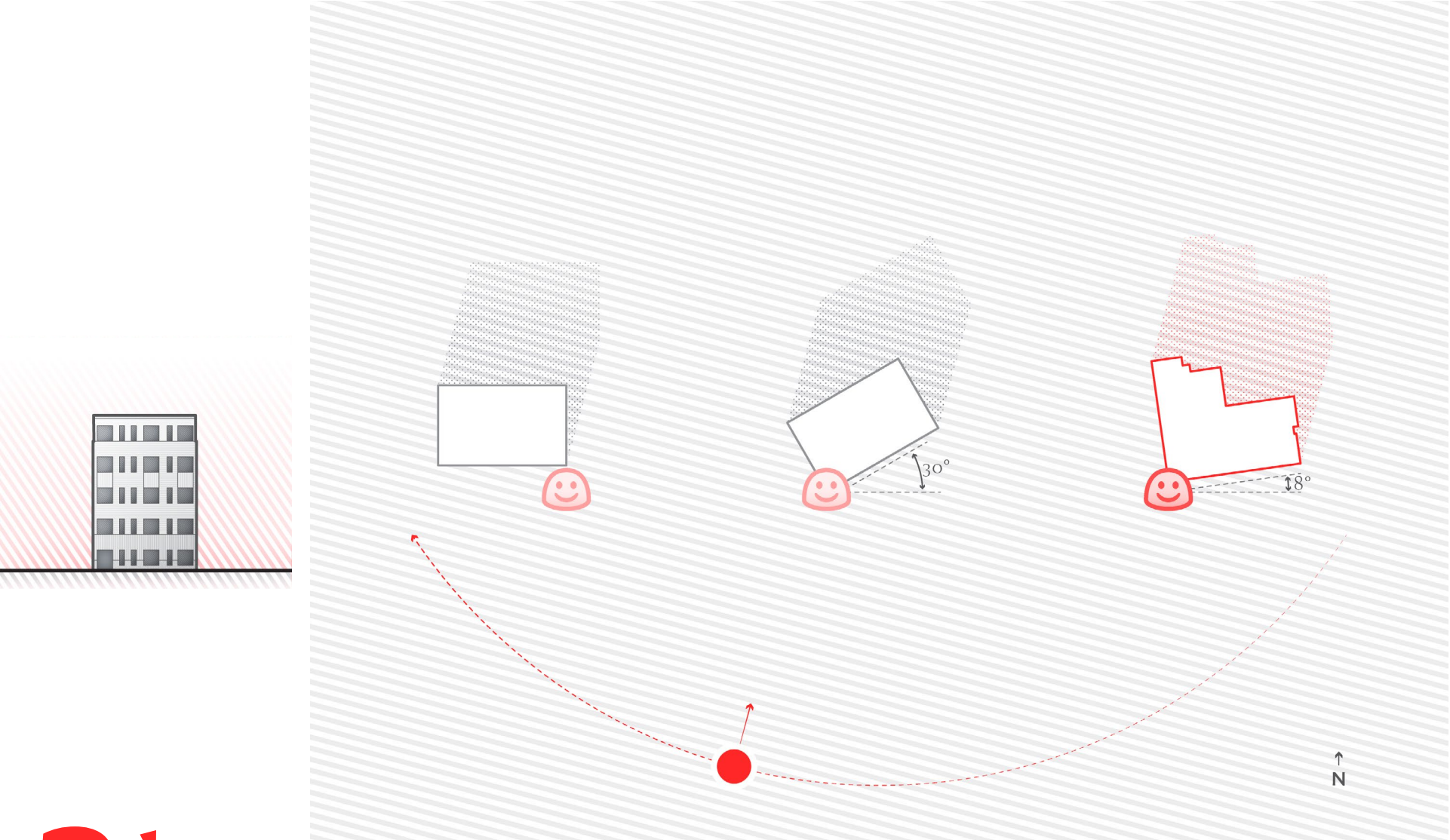

case study - glazing

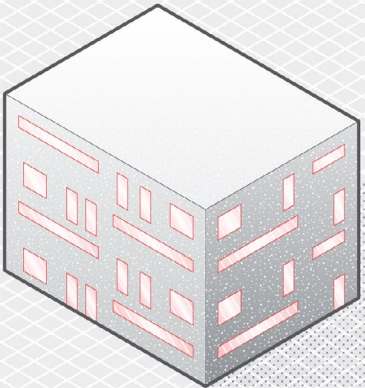

Window to Wall Ratio

23% of total surface
Window Specification
70 mm Upvc Tilt / Turn
U-value = 0.28
SHGC = 0.3

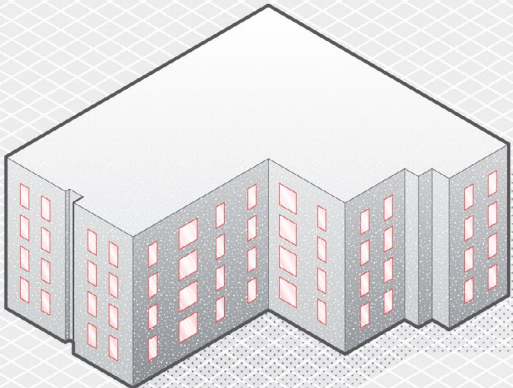

case study - airtightness

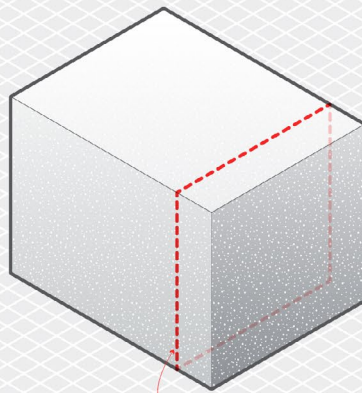

simple air barrier

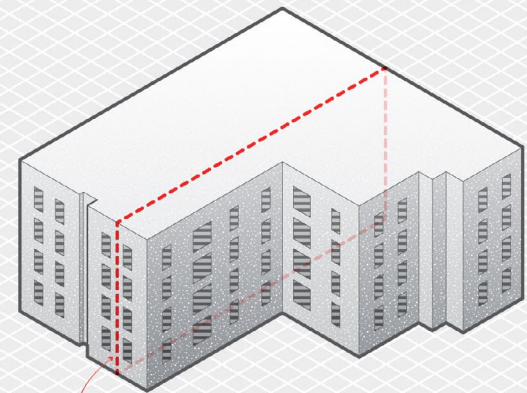
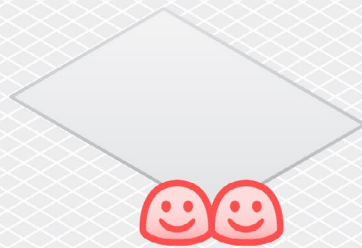

simple air barrier

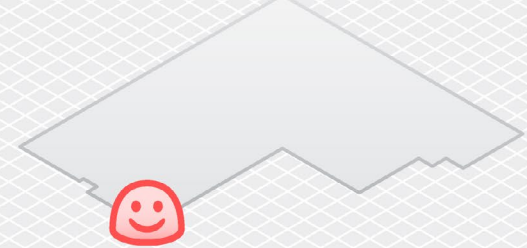

recommendations

Thermal bridge free shell

Window to wall ratio = <20% (total surface area)

Window u-value 0.28

Window performance criteria = Energy Star Air Leakage <0.3
cfm/ft² @ 75 pascals

**Building Air tightness = 0.06 ACH cfm /sf² of gross envelope
area @ 50 pascals**

DHW- 2.1 COP (heat pump)

Heat recovery ventilation 85% + 0.77 watts/CFM

R60 roof, R36 wall, R21 Slab

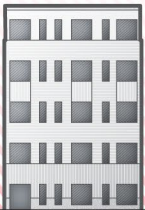

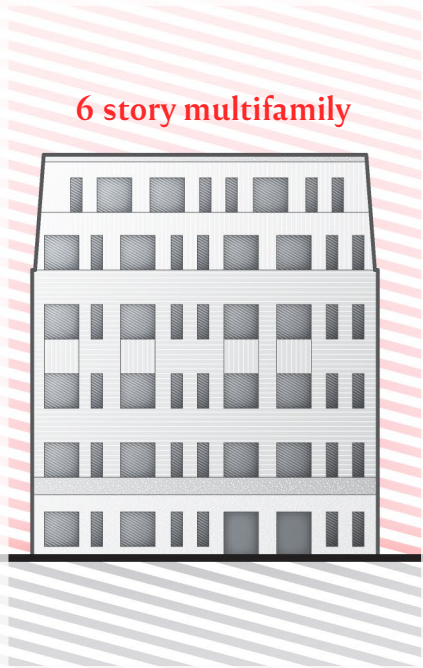
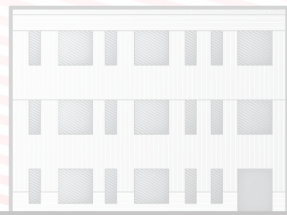

6 story multifamily

case study - results

Components	Stretch Code 2019	Zero Emission Building
Window U-value	0.3	0.22 min.
Window SHGC	no requirement	0.27 min.
Window/Wall ratio	no requirement	17%
Air-tightness (CFM ₅₀)	0.27 (3ACH)	0.13 min.
Heat Recovery %	no requirement	57% min.
DHW systems	gas	electric heat pump hot water
Heating Systems	heat pump w/ boiler	heat pump no fossil fuels
Roof R-value	R-49	R-60 min.
Walls R-value	R-20	R-36 min.
Floor R-value	R-10	R-21 min.
PV 75% roof area	no requirement	104 Kw
Incremental Construction Cost	0%	2.21% increase
Incremental Operational Cost	0%	26% decrease

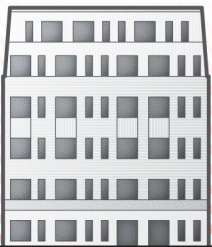

case study - assemblies

Stretch Code Building - Modeled Assemblies:

- Windows: Low E - 0.30 U-value
- Glazing: Clear - SGHC 0.27
- Air Tightness: ACH 0.27 CFM/ SF (code 3.0 ACH)
- Heat Recovery: no requirement
- Domestic HW: 80 gal. Hot water tank
- Heating System: Heat pump condenser + Boiler 2.8 COP
- Roof: 10" Joist w Sheathing with R-30 Cavity Insulation + R-24.5 Continuous Board - R50
- Wall: 2x6 wood framed wall + R-21 Cavity Insulation + R-5 Continuous Board
- Floor: Slab on grade with continuous R-10 insulation
- Photovoltaics: no requirement

Zero Emission Building - Modeled Assemblies:

- Windows: Triple pane- 0.22 U-value
- Glazing: Clear - 0.27 SHGC
- Air Tightness: ACH 0.06 CFM /SF
- Heat Recovery: HRV 65% efficiency - 0.77 watts /cfm
- Domestic HW: Heat pump hot water tank 2.1 COP
- Heating System: Heat pump 1 ton system - ductless - 3.0 COP
- Roof: 12" Joist w Sheathing with R-38 Cavity Insulation + R-28 Continuous Board - R60
- Wall: 2x6 wood framed wall + R-21 Cavity Insulation + R-15 Continuous Board
- Floor (Basement): Slab on grade w/ R-21 continuous insulation
- Photovoltaics: 104 Kw array

Note: For the sake of this study the project team modeled building products currently available on the market. Manufacturer names have been withheld.

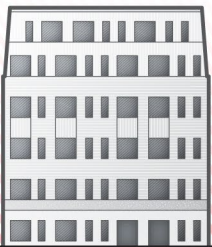

case study - assemblies

meets ZEB recommendations

modeled stretch assembly

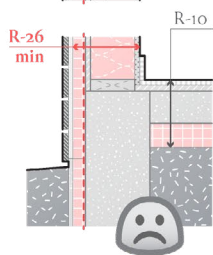
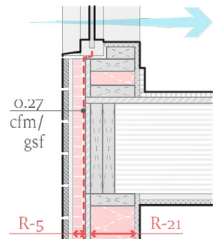
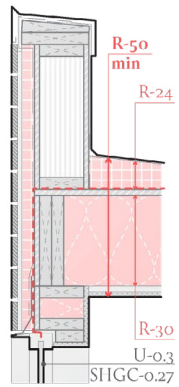

meets ZEB recommendations

modeled ZEB assembly

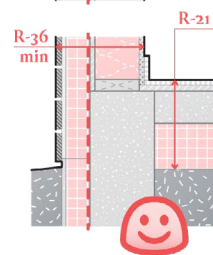
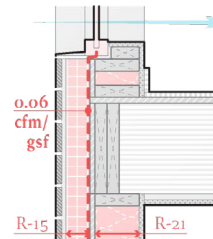
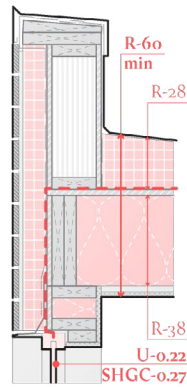

exceeds ZEB recommendations

pre-fab panel assembly

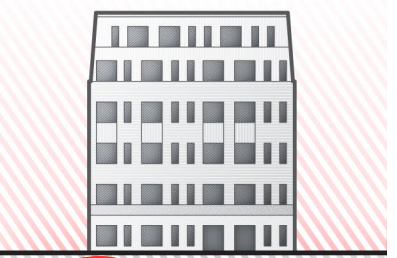
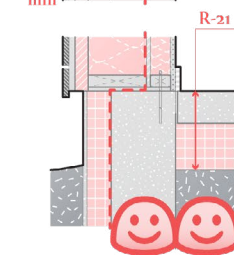
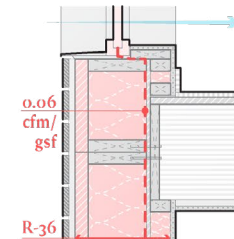
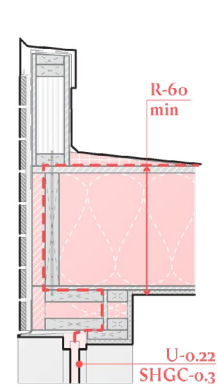

case study - massing

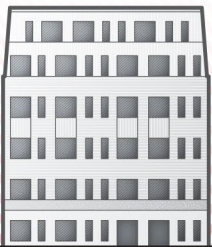

case study - orientation

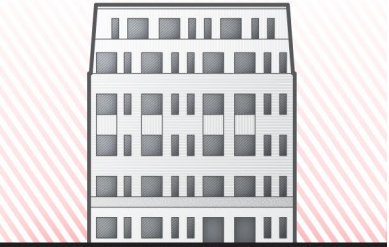
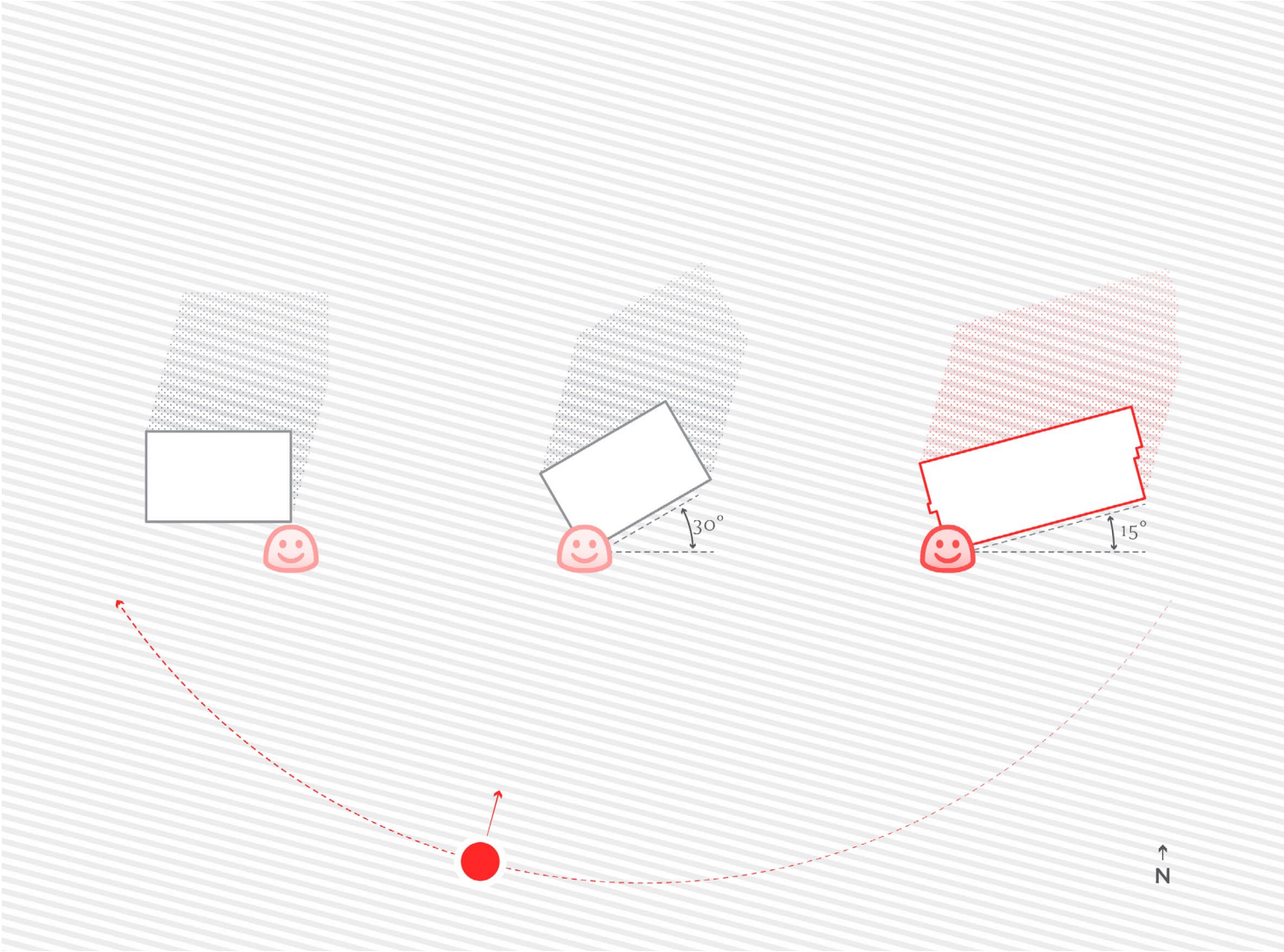

case study - glazing

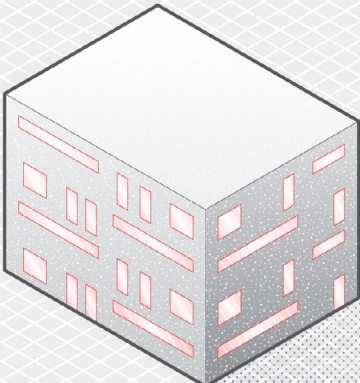

Window to Wall Ratio

17% of total surface
Window Specification
70 mm Upvc Tilt / Turn
U-value = 0.28
SHGC = 0.4

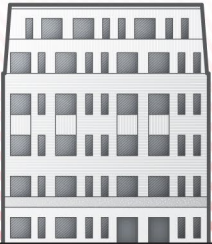
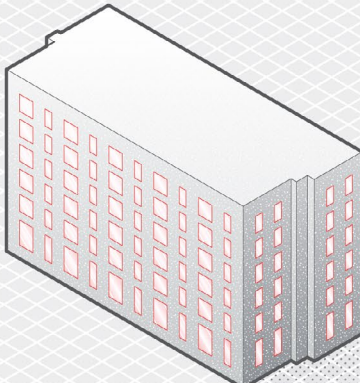

case study - airtightness

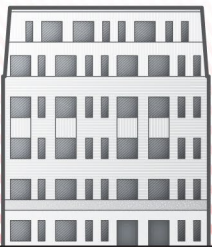
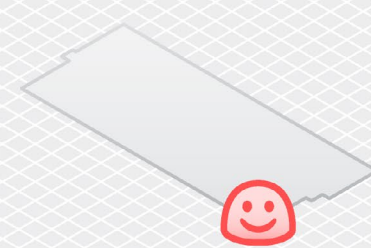
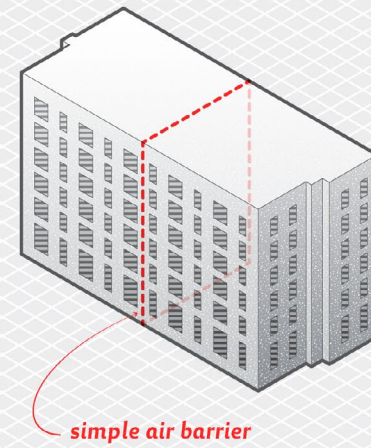
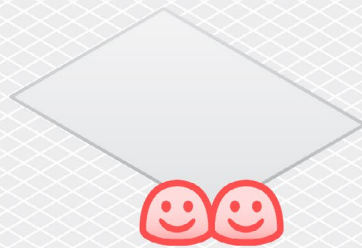
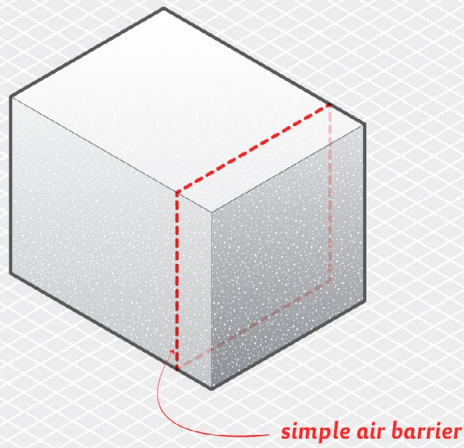

recommendations

Thermal bridge free shell

Window to wall ratio = $\leq 20\%$ (total surface area)

**Increased WWR above 20% results in a triple glazed window
0.18 u-value is recommended**

Window performance criteria = Energy Star Air Leakage < 0.3
cfm/ft² @ 75 pascals

Building Air tightness = 0.06 ACH cfm /sf² @ 50 pascals

Heat pump DHW- 2.1 COP

Heat recovery ventilation 65% + 0.77 watts/CFM

R60 roof, R36 wall, R21 Slab

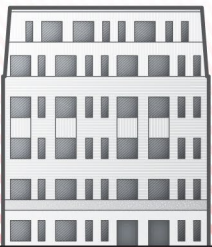

4 | appendices

a | sources and resources

b | variations

c | tools and resources for embodied carbon

d | about this guide

sources and resources

475 High Performance Building Supply (2019)

Double-Stud Smart Enclosure System
Version 2.1

9th Edition MA Residential Code 780 CMR 51.00

Annual Energy Outlook 2019

with projections to 2050
Prepared by the U.S. Energy Information Administration (EIA), the statistical and analytical agency within the U.S. Department of Energy. www.eia.gov/aeo

Annual Housing End Use: 2015 Residential Energy Consumption Survey: Energy Consumption and Expenditures Table CE4.7

Architect's Guide to Building Performance: Integrating Simulation into the Design Process

AIA guide for performance simulation

BC Energy Step Code Design Guide:

The BC Energy Step Code Design Guide is published by BC Housing in collaboration with BC Hydro, the City of Vancouver, the City of New Westminster, and the Province of BC. This guide provides information on the key strategies and approaches to meeting the Energy Step Code in mid- and high-rise (Part 3) wood-frame and noncombustible residential buildings within British Columbia.

Buildings. In: Climate Change 2014: Mitigation of Climate Change. Contribution of Working Group III to the Fifth Assessment Report of the Intergovernmental Panel on Climate Change

Lucon O., D. Ürge-Vorsatz, A. Zain Ahmed, H. Akbari, P. Bertoldi, L. F. Cabeza, N. Eyre, A. Gadgil, L. D. D. Harvey, Y. Jiang, E. Liphoto, S. Mirasgedis, S. Murakami, J. Parikh, C. Pyke, and M. V. Vilarinho, 2014 [Edenhofer, O., R. Pichs-Madruga, Y. Sokona, E. Farahani, S. Kadner, K. Seyboth, A. Adler, I. Baum, S. Brunner, P. Eickemeier, B. Kriemann, J. Savolainen, S. Schlömer, C. von Stechow, T. Zwickel and J.C. Minx (eds.)]. Cambridge University Press, Cambridge, United Kingdom and New York, NY, USA.

Carbon Free Boston Summary Report 2019

Boston Green Ribbon Commission and Boston University

City of Boston Greenhouse Gas Emission Inventory 2005-2016

<https://data.boston.gov/dataset/greenhouse-gas-emissions>

Household Energy Use in Massachusetts

A closer look at residential energy consumption survey
www.eia.gov/consumption/residential/

IEA 2019 - Perspectives for the Clean Energy Transition: The Critical Role of Buildings

www.iea.org

Massachusetts DOER Policy Planning and Analysis Division - Projected Household Heating Costs for 2019/2020

www.mass.gov/info-details/household-heating-costs

Moisture Management for High R-Value Walls

R. Lepage, C. Schumacher, and A. Lukachko
Building Science Corporation

The Economics of Zero-Energy Homes: Single-Family Insights.

Rocky Mountain Institute, 2019.
Petersen, Alisa, Michael Gartman, and Jacob Corvidae.
www.rmi.org/economics-of-zero-energy-homes

Zero Energy Building Pathway to 2035

Whitepaper Report of the Rhode Island Zero Energy Building Task Force
Prepared by National Grid, November 2016

variations

Project Type	Window U-value	SHGC	Airtightness	Heat Recovery	Electric Efficiency	DHW COP	HP COP	Roof R-val	Wall R-val	Floor R-val	EUI (kBTU)	Annual Operating Cost	CO2e
Townhouse Flats- 0.77 lbs CO2e/pp													
Ideal - cost effective	0.22	0.27	0.06	0.57	0.59	2.1	3	60	36	21	18	\$1,450	0.77
	0.18	0.27	0.05	0.85	0.53	2.1	3	60	46	36	17	\$1,400	0.75
3 Story- 0.77 lbs CO2e/pp													
Ideal - cost effective	0.22	0.27	0.06	0.57	0.59	1	3	60	36	21		\$1,200	0.77
	0.22	0.27	0.05	0.57	0.59	2.1	3	60	36	21	22	\$1,050	0.67
	0.18	0.27	0.05	0.85	0.53	2.1	3	60	36	21	20	\$950	0.61
4 -5 Story - 0.77 lbs CO2e/pp													
Ideal - cost effective	0.22	0.27	0.06	0.85	0.53	1	3	60	36	21	20.5	\$1,100	0.77
	0.18	0.39	0.05	0.85	0.53	1	3	60	36	36	20	\$1,100	0.75
	0.18	0.39	0.05	0.85	0.53	2.1	3	60	36	36	16.8	\$882	0.62
6+ Story - 0.77 lbs CO2e/pp													
Ideal - cost effective	0.22	0.27	0.06	0.57	0.59	2.1	3	60	36	21	18	\$1,100	0.77
	0.22	0.27	0.05	0.85	0.53	2.1	3	60	36	21	16	\$950	0.65

tools and resources for embodied carbon

introduction

“Embodied carbon is an urgent issue because the emissions we release in the next 20 to 30 years are critical to keeping global temperatures at tolerable levels.” - Buildinggreen.com

In order to reduce the overall GHG impacts of our buildings, we must consider not only the regular operating energy use, but also the amount of impact that comes from the production, transportation, and assembly of the materials used. It is possible to deliver a building that produces more energy in a year than it uses, yet incorporates such heavy-footprint materials that it could take many decades for the energy saved in operations to make up for the initial GHG impacts of the materials.

Therefore, the requirements laid out in this book must include considerations for the choice of materials in major building elements and assemblies. The relatively

nascent field of material footprint research cannot offer us comprehensive data that accounts for the incredible complexity of global production and supply chains. However, it can very clearly point us in a few key directions that provide best practices and general rules of thumb.

This chapter includes optional best practices emerging from the latest and most comprehensive material footprint research, resources for teams who wish to quantify the impacts of their material decisions, and finally a curated “red list” of materials that cannot be used in certain applications as part of the DND ZEB requirements.

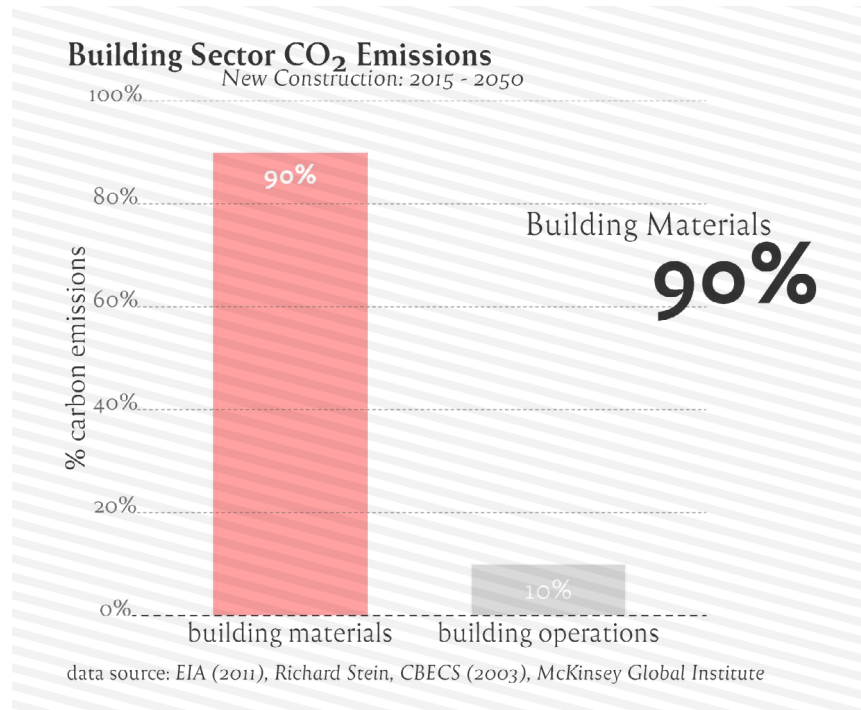

resources for quantifying

Carbon

(quotes from buildinggreen.com article)

Architecture 2030 is introducing the Carbon Smart Materials Palette, a tool laypeople like architects and designers can use to identify and take action on embodied carbon “hot spots” in building materials. Users can learn more about the Carbon Smart Materials Palette on the Architecture 2030 website.

“A newer resource is the Quartz database, which has basic environmental-impact and health-related data on 102 common building materials. Carbon data come from thinkstep, an internationally respected life-cycle analysis firm, and are specific to the U.S.” Bath Inventory of Carbon and Energy (ICE), which has the advantage of being a long-respected source of embodied carbon data. The main drawback of ICE is that it’s not updated frequently; data are also specific to the U.K.

BEES (Building for Environmental and Economic Sustainability) is a similar tool offering North American data.

WBLCA

The only way to get a really clear picture of how one material or system compares to another in the context of a building project is to use whole-building life-cycle assessment, or WBLCA. This process looks at multiple impacts of building materials, including global warming potential, over their entire life cycle—from extraction and manufacturing through the landfill or recycling plant.

Two major tools dominate the WBLCA market in North America—Athena Impact Estimator and Tally.

The Carbon Leadership Forum, a network of experts on the carbon impacts of the building industry, has developed an LCA practice guide aimed at building professionals. Makers of WBLCA software tools also offer trainings to help users navigate the software and interpret results.



about this guide

The **DND Guidebook for Zero Emission Buildings** is published by the City of Boston - Department of Neighborhood Development in collaboration with project leads Placetaylor and Thornton Tomasetti.

These guidelines provide key strategies for residential construction to meet the goal of a carbon-neutral Boston by the year 2050. It presents these strategies in the context of the building typologies most common to the city's housing in 2019. However, many of these strategies can be employed across all types of construction and programming to achieve more efficient buildings.

These guidelines are intended to be a clear and legible resource for all parties involved in the planning, design, construction, and renovation of the Boston housing supply including local governments, architects, developers, and contractors.

Please refer to **“how to use this guide”** for further explanation of how these guidelines should be employed based on your project type.

disclaimer

The greatest care has been taken to confirm the accuracy of the information contained herein. However, the authors, funders, publisher, and other contributors assume no liability for any damage, injury, loss, or expense that may be incurred or suffered as a result of the use of this publication, including products, building techniques, or practices.

The views expressed herein do not necessarily represent those of any individual contributor, Placetaylor, Elton Hampton Architects, Thornton Tomasetti, Bensonwood, the Boston Environment Department, the Boston Planning and Development Agency, the Boston Department of Neighborhood Development, or the City of Boston itself. As products and construction practices change and improve over time, it is advisable to regularly consult up-to-date technical publications on building science, products, and practices, rather than relying solely on this publication.

It is also advisable to seek specific information on the use of products, the requirements of good design and construction practices, and the requirements of the applicable building codes before undertaking a construction project. Retain consultants with appropriate engineering or architectural qualifications, as well as the appropriate municipal and other authorities, regarding issues of design and construction practices.

The use of this guide does not guarantee compliance with code requirements, nor does the use of systems not covered by this guide preclude compliance.

thank you